

Amtrak Cascades Improvement Program 2024

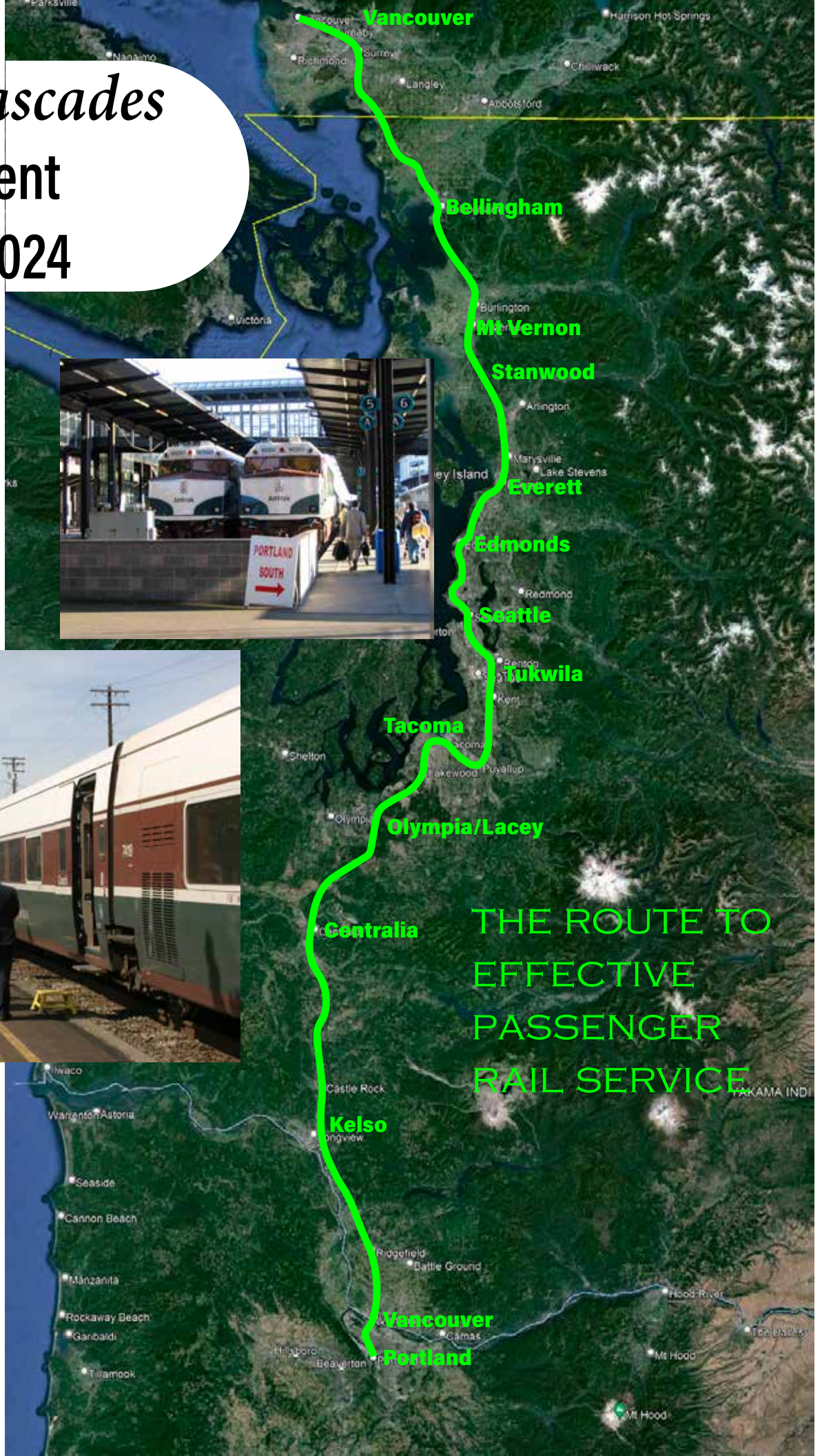

THE ROUTE TO
EFFECTIVE
PASSENGER
RAIL SERVICE

March 31, 2024



for
Rail Can't Wait Campaign
Climate Rail Alliance
Solutionary Rail

Amtrak *Cascades* Improvement Program 2024



for
Rail Can't Wait Campaign
Climate Rail Alliance
Solutionary Rail

March 31, 2024

Contents

Executive Summary — 3

1. Introduction — 5

2. The Mission and the Urgency — 7

Highway Congestion - The Original Mission — 7

Climate Change - The New Urgency — 7

3. Amtrak Cascades from Study to Plan to Service — 9

1983 High Speed Rail Passenger Service Western Washington Corridor Economic Feasibility Study — 9

The Legislature Takes Action — 9

The Second High Speed Ground Transportation Study — 10

Evolution of the Pacific Northwest Rail Corridor and the Amtrak Cascades Service — 11

LRP Current Relevance — 12

4. Congested Freight Rail to Effective Passenger Service — 13

Starting With a Railroad That Couldn't Accommodate Effective Passenger Service . . . or Effective Freight Service — 13

The Master Agreement — 13

For Freight, 340 Miles of Horrendous Congestion and Delay — 14

Vancouver BC - Everett — 14

Everett - Nisqually — 14

South of Nisqually — 16

Centennial (Amtrak Olympia/Lacey station) — 17

Centralia — 17

Rocky Point - Kalama — 17

Vancouver — 17

Portland — 17

Figuring Out What to Fix and How — 17

Capacity — 17

Analysis — 17

Simulation — 17

Analytical — 18

Analytical-Simulation Method: Joint WSDOT-BNSF Analysis — 18

Hose Analysis — 18

Fixing Freight Problems Makes Room for Amtrak Cascades — 19

Vancouver BC - Everett — 19

Everett - Tacoma — Sound Transit improves the railroad to accommodate Sounder and Amtrak Cascades — 19

Freight Congestion South of Tacoma — 21

Centennial (Amtrak Olympia/Lacey station) — 21

Centralia — 21

Rocky Point-Kalama — 22

Vancouver — 22

Portland — 22

Adding Infrastructure for Passenger Trains — 23

Maximum Speed - Why 110? — 24

5. The 2010 American Recovery and Rehabilitation Act Improvements — 25

Rocky Point-Kalama — 25

Vancouver — 26

Portland — 27

6. Long Range Plan as a Service Development Plan — 29

Corridor ID and Service Development Plan — 29

The LRP as an SDP — 29

Environmental Review — 30

FRA on the Use of Prior Work — 30

7. Amtrak <i>Cascades</i>, Covid-19, Remote Work, and Commuting	— 31
8. The WSDOT Service Development Plan Alternatives	— 33
The WSDOT Service Development Plan Alternatives	— 33
Proposed Service Alternative F	— 34
20 Years is Too Long for Program Implementation	— 35
9. Immediate Projects to Improve Passenger Service	— 37
Point Defiance Bypass	— 37
110 mph Passenger Track between Nisqually and Centralia (Wabash - Big Hanaford Road)	— 38
Travel Time Difference	— 40
Project Cost	— 40
10. Funding for Immediate Improvement	— 43
Previous Grant Programs	— 43
CRISI Grants	— 43
Climate Commitment Act (CCA)	— 44
Federal-State Partnership for Intercity Passenger Rail Grant Program	— 44
11. Further Passenger Service Improvement Projects	— 47
12. Build New or Improve The Existing?	— 49
Build New	— 49
Improve Existing	— 49
Big Benefits - Short Time	— 50
Appendix A Kalama - Kelso Before and After Passenger Projects	— 51
Appendix B - Additional Description of the LRP as an SDP	— 53
Appendix C - Capital Cost	— 59
Appendix D Tilting Trains	— 69
Appendix E Schematic of LRP Infrastructure Program	— 73
Appendix F: Glossary	— 81

Executive Summary

This report addresses the development of Washington State's Amtrak *Cascades* intercity passenger rail program, its original mission and current relevance to the challenge of reducing climate emissions and providing our region with alternatives for mobility.

It addresses how the program developed and implemented a plan to fix the long list of freight rail problems that made immediate passenger service improvement impossible, then continued improvements to accommodate effective passenger service.

The Long Range Plan for Amtrak *Cascades* (LRP) resolved critical issues for both freight and passenger use of the shared corridor, designing passenger service to meet the mandates set forth by the Washington State Legislature. It has been only partially completed and needs to be re-prioritized.

The Legislature must give new direction to the Washington State Department of Transportation to re-frame the program as a vital state asset for optimal mobility and timely emissions reduction.

The report explains how the LRP qualifies as a Service Development Plan (SDP) that must be included in the record of previous work on the corridor, updated to meet the new requirements of the Federal Railroad Administration (FRA) and be integrated by the Washington State Department of Transportation (WSDOT) in the final option for the Amtrak *Cascades* SDP.

Two projects are vital to program success. It is urgent that the state proceed with the Point Defiance Bypass alignment change and the dedicated passenger track between Nisqually and Centralia. These projects will correct the biggest choke point on the corridor, provide essential improvements in reliability and reduced travel time and lay the foundation for increased frequency. These and other projects should be appropriate candidates for state and federal funding for engineering and implementation, creating an effective rail service within a time frame that matters.

The Report is intended to provide essential background and current status evaluation so that the Amtrak *Cascades* Program can again become a focal point for developing an effective and timely transportation alternative for Washington State.



1. Introduction

Full development of the Amtrak *Cascades* service as described in the Long Range Plan for Amtrak *Cascades* (LRP) must again be a priority for Washington State and all jurisdictions that are served by the corridor.

The Amtrak *Cascades* service, developed in 1991-2006, was initiated by the Washington State Legislature in 1991 in response to unacceptable levels of highway congestion in the Vancouver British Columbia (BC) - Portland, Oregon corridor. The Legislature directed the Washington State Department of Transportation (WSDOT) to develop a plan that would provide the greatest possible mode shift from highway to rail.

Climate change was not a widely publicized subject during those years. Air pollution from vehicle emissions was the greatest environmental concern from transportation. In the ensuing years, climate change has become a widely acknowledged crisis.

The United Nations Intergovernmental Panel on Climate Change (IPCC) has stated in several consecutive reports over a period of more than a decade that greenhouse gas (GHG) emissions must be reduced by about half by 2030 to prevent irreversible and eventually catastrophic climate change. However, the warnings have not been taken seriously. Current estimates predict a tipping point sooner than 2030. There is no time to waste.

It is well known that the transportation sector is the biggest emitter of GHG, that roadway traffic is the biggest culprit, and that rail is the most efficient and lowest emitting mode per passenger or ton-mile. We also know that building more and wider highways induces more highway congestion. We know that highways are dangerous, and that tire particulate endangers wildlife. We understand that Washington expects a huge influx of people in the coming decades and that equitable transportation means providing alternatives to driving and flying. We know that rail solutions are needed, and that local communities and economies will flourish when transit stops are hubs for sustainable development. The only question remaining is what type of rail will best serve us in a cost effective and timely manner.

Rail transportation is an essential climate emergency response. However, rail assets need to be well utilized and the service must be effective. One train a day or an occasional train, unreliable service, and travel time that can't compete with driving is not effective service. The LRP represents effective rail service on a shared corridor. The planned travel time is comfortably competitive with highway and air. The frequency, hourly between Seattle and Portland and bi-hourly between Seattle and Vancouver BC, provides the convenience needed for an attractive alternative. Furthermore, hourly headways allow for planning of additional service also on hourly headways. The Vancouver BC - Portland service day could be lengthened, and additional trains could be added between Seattle and Vancouver BC without additional infrastructure.

The LRP has for the past several years been misrepresented and disregarded. This disregard is inhibiting full implementation of the Pacific Northwest Rail Corridor (PNWRC) program and the Amtrak *Cascades* service as designed. WSDOT has described the LRP as aspirational, an exercise to see what could be done with unlimited budget. WSDOT states that the ports are concerned that additional passenger trains will inhibit or prohibit freight service. They also state that BNSF Railway objects to the program and will never allow such expansion to happen. These claims are unfounded and must be challenged.

WSDOT is pursuing a new passenger rail development plan for the corridor. In 2024, WSDOT will evaluate five candidate service options for development. None of the five are comfortably competitive with highway travel in terms of travel time or reliability, and proposed infrastructure is insufficient to support proposed frequencies.

The immediate priority is a new alignment on the Point Defiance Bypass, eliminating 2.9 miles of speed restricting curvature including a 30 mph curve, the lowest speed segment between Seattle and Portland. This change is essential to achieving the 2 hour 30 minute Seattle - Portland travel time of the LRP. This project in conjunction with the Nisqually-Centralia high speed dedicated passenger track relieves a significant source of congestion and delay.

The Washington Legislature must correct misinformation, re-frame its expectations of WSDOT and redirect WSDOT to prioritize the Amtrak *Cascades* corridor improvements and bring the program to completion, shortening the implementation time frame by about half to meet the challenges of regional mobility and the urgent need for transportation emissions reduction.



Amtrak Cascades

THE ROUTE TO
EFFECTIVE
PASSENGER
RAIL SERVICE

2. The Mission and the Urgency

Highway Congestion - The Original Mission

The legislation that started the program cited unacceptable levels of congestion of major transportation corridors. In the past decade, attempts to address congestion by highway expansion have continued while the rail solution has languished.

We know that highway congestion exists, but there is no statistical data to measure it. The Texas Transportation Institute (TTI) developed data for congestion within cities, published by the US Bureau of Transportation Statistics. The dataset includes data for the period of 1982 - 2011. TTI published a website article in 2012 about the need for better ways to measure roadway congestion.

We must rely on experience. For example, a trip between Seattle and Olympia might take an hour or it might take three. Navigation software may show that a trip from Seattle to Portland can be made in a little less than three hours. However, in reality, that travel time is a suggestion. People in western Washington waste a lot of time, not only in traffic, but in 'just in case' time to arrive on time.

Climate Change - The New Urgency

Climate change was not a common topic in 1991 when the PNWRC program started. Climate change is often discussed now. The effects are plainly visible and steadily increasing in intensity.

The IPCC has stated in a series of reports for over a decade that GHG emissions must be reduced by about 50 percent by 2030 to avoid irreparable catastrophic climate change. However, there are climate scientists who agree that the change is accelerating faster than predicted, largely because of lack of substantive action to date. There are already frequent occurrences of radically changed weather patterns as well as an overall prolonged drought condition in the Northwest.

Rail transportation is an important part of an effective climate emergency response. Even with current diesel locomotive power, rail transportation needs only about one third the energy of equivalent highway transportation and produces about one third the emissions. Rail is the mode that consumes less fuel and produces fewer emissions.

The need to reduce energy consumption has also become urgently important. Increasing electrification in response to the climate emergency has caused the North American Electric Reliability Corporation to predict a growing possibility of electric power shortages starting in 2024.

In 2008, in response to impending climate change and the effects of highway congestion, the Legislature required limits for GHG emissions in RCW 70A.45.020. The limits have not been met. Emissions have increased. The Legislature also established in 2008, a Vehicle Miles Traveled (VMT) reduction goal of 18 percent by 2020 in RCW 47.01.440. VMT was reduced by only two percent in 2020.

Data in the LRP shows that the emissions reduction of the fully developed Amtrak Cascades service as well as the effect on congestion can be substantial as shown in Table 1. Consider that the western Washington population has grown five percent more than expected when the projections were made in 2005.

Passengers Low	Passengers High	Passenger Miles Low	Passenger Miles High
2,995,300	3,295,000	401,368,054	494,871,703
Autos Low: 2 Passengers Per Car	Autos High: 2 Passengers Per Car	Vehicle Miles Low: 2 Passengers Per Car	Vehicle Miles High: 2 Passengers Per Car
1,497,650	1,647,500	200,684,027	247,435,852
Gallons Low: 30 Miles Per Gallon	Gallons High: 30 Miles Per Gallon	Highway Metric Tons CO2 Low: 0.008887 per gallon	Highway Metric Tons CO2 High: 0.008887 per gallon
6,689,468	8,247,862	54,449	73,299
Rail Metric Tons CO2 Low: 1/3 Highway	Rail Metric Tons CO2 High: 1/3 Highway	Rail CO2 r\Reduction Low (continued diesel)	Rail CO2 Reduction High (continued diesel)
19,797	24,408	39,653	48,890
Net Revenue Low	Net Revenue High		
(\$1,130,623)	22,425,706		

Table 1. Effectiveness of the completed LRP



3. Amtrak Cascades from Study to Plan to Service

1983 High Speed Rail Passenger Service Western Washington Corridor Economic Feasibility Study

In 1983, the Washington State Legislature commissioned an economic feasibility study of high speed rail passenger service between Vancouver BC and Portland. This study followed a 1972 study of Everett-Olympia transportation problems and a 1976 West Coast Corridor Study examining intercity rail transportation improvements.

The study was commissioned for examination and evaluation of high speed (150-180 mph) and super high speed rail (more than 180 mph) technology. The Legislature amended the scope to include improved Amtrak service.

The study evaluated and compared the three modes:

- Existing technology would allow 100 mph passenger service on the existing route with eight trains per day. Infrastructure and right of way cost would be low. Service could be improved incrementally as infrastructure was improved. Tilting trains (Appendix D, page 69) could be used to decrease travel time with minimum investment. 100 mph was suggested to reduce speed differential and reduce the difficulty of operating on tracks shared with freight trains.
- The report stated that high speed up to 180 mph was existing technology that could apply to western Washington, would be very costly to build because of the need for new dedicated right of way, and would need extensive tunneling but would have lower operating cost and higher ridership. High speed rail with a maximum speed of 180 mph would not be financially feasible until after 2000.
- 250 mph maglev and linear motor technology would not be ready for many years.

The report made six recommendations:

1. Establish state goals and objectives for rail passenger service in major travel corridors, including the western Washington Corridor.
2. Determine the appropriate level of service and establish a program of upgrading Amtrak rail passenger service to achieve state-set goals and objectives in a cost effective manner.
3. Based upon the goals and needs identified from actions contained in Recommendations 1 and 2 above, evaluate the basis of state funding to upgrade existing Amtrak service and better integrate local public transportation with rail passenger service.
4. Preserve existing rights-of-way which may be used for public transportation corridors in the future.
5. Recognize, in the State's long-range planning process, the potential for higher speed intercity rail passenger systems.
6. Monitor socio-economic and technological conditions as triggers to higher speed systems.

The rail service between Portland and Seattle in 1983 consisted of two long distance trains, the Seattle-Los Angeles *Coast Starlight*, the Seattle-Salt Lake City Pioneer, and the *Mount Rainier*. There was no Seattle-Vancouver BC service. It was discontinued in 1980.

No action was taken until 1991.

The Legislature Takes Action

Substitute House Bill 1451 of 1991 stated:

The legislature recognizes that major transportation corridors in this state are reaching unacceptable levels of congestion. Proposed improvements such as extension of the HOV-lane system or regional high-capacity systems, can, at best, only temporarily reduce the rate at which congestion increases. Further, such improvements do not address cross-state travel demands, whether north-south or east-west.

Therefore, the legislature finds that 1991 is an appropriate time for the legislature and the governor to direct that a comprehensive assessment be made of the feasibility of developing a high-speed ground transportation system within the state and that a plan be developed for implementation of potential alternatives.

Congress has set aside federal funds in the amount of five hundred thousand dollars for the state of Washington to carry out such an assessment, with the stipulation that the state provide an equal amount of state funds for the effort.

The legislation required a plan for implementation by October 15 1992.

Engrossed Substitute House Bill 1231 of 1991 stated:

By December 15, 1991, the department of transportation, in cooperation with local units of government and Amtrak, shall submit to the legislative transportation committee a program to improve Amtrak services in Washington. Upon submittal and approval of the program recommendations by the legislative transportation committee, the department may expend the amount provided from the transportation fund -state for program implementation.

The legislation allocated \$56,283,000 for public transportation and rail programs, the High Capacity Transportation Account, and for planning and research.

The Second High Speed Ground Transportation Study

The Legislature commissioned a second High Speed Ground Transportation (HSGT) study in 1991. The Governor, the Chair of the Legislative Transportation Committee, and the Chair of the Transportation Commission jointly appointed the High-Speed Ground Transportation Steering Committee. The committee of 15 members included

- Cities and counties, including both elected officials and planners, and if possible, representatives of regional transportation planning organizations;
- Public transportation systems,
- The United States Department Of Transportation,
- Public ports,
- The private sector, including:
 - The financial community,
 - The engineering and construction community,
 - Railroad companies,
 - Environmental interests,
 - The legal profession.

The committee included four liaison positions:

- The Governor or a designee,
- Four legislators, one from each caucus of each house, appointed by the Chair of the Legislative Transportation Committee,
- The Chair of the Transportation Commission.

The study findings included

- Steps should be taken now to demonstrate the service potential of a high quality rail service with full integration with other urban transport modes and to develop further the support needed for statewide funding.
- The State of Washington, in concert with Oregon and British Columbia, should continue its commitment to upgrade Amtrak service and take further action now to build support for an HSGT program.
- The N-S Corridor between Everett and Portland offers the best near term opportunity for implementing a high quality intercity rail service. Completion of this corridor north to Vancouver, B.C. would assist the northwest economy in reaching its full intermodal potential.
- The E-W Corridor between Spokane and Seattle offers the best long term opportunity to utilize the speed advantage of true high speed service and provides attractive long term opportunities for supporting increased economic activity and diversity east of the Cascades range.
- We do not have an extensive, well-developed passenger rail network with good intermodal connections in the major urban areas. We do not have high passenger rail ridership and a "culture" which is receptive to a high quality rail passenger service. What we do have are extensive, well-developed inter-city highway and air transport modes which are reaching serious levels of congestion. Because of the financial and environmental costs of expanding either of these modes, the development of a third mode of intercity transport merits serious consideration. It should be noted, however, that the process of developing this third inter-city mode would be time consuming and costly (just as it has been with the highway and air modes).

The potential benefits are great, but without the existing ridership base and a market attuned to the benefits of high quality rail service it will require a patient, measured approach to developing both ridership and the broad based funding support necessary.

The detail involved in making something happen can be substantially different from the big picture view of what should happen. RCW 47.49.020 of 1993 directed a program that would be the basis for the LRP.

1. Implement high-speed ground transportation service offering top speeds over 150 m.p.h. between Everett and Portland, Oregon by 2020. This would be accomplished by meeting the intermediate objectives of a maximum travel time between downtown Portland and downtown Seattle of two hours and thirty minutes by the year 2000 and maximum travel time of two hours by the year 2010;
2. Implement high-speed ground transportation service offering top speeds over 150 m.p.h. between Everett and Vancouver, B.C. by 2025;
3. Implement high-speed ground transportation service offering top speeds over 150 m.p.h. between Seattle and Spokane by 2030.

After receiving a draft of the report, the Legislature directed WSDOT to begin planning high quality passenger rail service between Vancouver BC and Portland.

A set of reports informally called "The Gap Study" established the basis for further development of the LRP. The Gap Study suggested a timetable of nine Seattle - Portland and eight Vancouver BC - Portland round trips per day (17 trains per day between Seattle and Portland). The Legislature, concerned with the amount of potential subsidy, directed WSDOT to develop a service of 10 Seattle - Portland, three Vancouver BC - Portland and one Seattle - Vancouver round trip per day (13 trains between Seattle and Portland). In late stages of development, one additional Vancouver BC - Portland trip (total of four, making the Seattle - Portland service 14 trains) was found to cost less than the prescribed number of trains.

In consultation with WSDOT, the legislature established a revised goal of high quality Vancouver BC - Portland Amtrak service by 2015. The goal was subsequently revised to 2018 because of revenue and funding problems. Seattle - Spokane service had a preliminary feasibility study that demonstrated the feasibility of Amtrak service. The Legislature put off action on Seattle - Spokane service until Vancouver BC - Portland improvements were finished.

Because the prerequisite high quality supporting service cited in the legislation would not be available for twenty years, consideration of high speed rail traveling at 150 mph or more within the time specified in the legislation was discontinued.

Evolution of the Pacific Northwest Rail Corridor and the Amtrak Cascades Service

Coincident with the 1991 state legislative action, Congress passed, and President George HW Bush signed into law the Intermodal Surface Transportation Efficiency Act of 1991 (ISTEA). The PNWRC was one of five corridors selected to participate in a rail improvement program.

In 1991, the single regional Amtrak train between Seattle and Portland was called *Mount Rainier*. It was changed to *Cascadia* in 1995 to reflect the extension to Eugene from Portland.

Congress passed the Swift Rail Development Act PL 103-440 in 1994, providing funding for high speed rail development in specified corridors. FRA specified eight corridors, one of which was Vancouver BC - Eugene. Maximum speed was not specified in the act.

As the PNWRC program developed, a train called *Northwest Talgo* between Seattle and Portland was added in 1994 as a demonstration of Talgo trains. It became *Mount Adams*. The train restoring service between Seattle and Vancouver BC in 1995 was called *Mount Baker International*.

In spring of 1998, Amtrak adopted the brand name *Pacific Northwest* for the Vancouver BC - Eugene service in lieu of naming individual trains. The name was changed to *Cascades* in the fall of that year.

Just as the Northeast Corridor, the Boston-Washington DC route has two brands of service, *Northeast Regional* and *Acela*, each with numbered, not named trains, the PNWRC has a brand of service, Amtrak *Cascades* with numbered, not named trains.

Although the name Amtrak *Cascades* has become synonymous with the program that created it, the corridor and program are PNWRC, just as *Northeast Regional* and *Acela* are brands of train service on the Northeast Corridor.

With the advent of the Amtrak *Cascades* brand name, the PNWRC planning process and documents became known as the Long Range Plan for Amtrak *Cascades* (*LRP*).

LRP Current Relevance

The LRP was continually developed and updated into 2006. Development and updating stopped after 2006. WSDOT published Amtrak *Cascades* Mid-Range Plan in 2008. This plan considered eight trains between Seattle and Portland as the maximum service and did not consider travel time improvement. There is no mention of maximum speed over 79 mph. WSDOT has stated that the LRP is obsolete and irrelevant. Its current Amtrak *Cascades* service planning is based on that concept.

However, the 2019 State Rail Plan, page 47, presents Low, Moderate, and High growth scenarios for planning. The LRP was developed to maximize ridership rather than to react to potential ridership. A well-known axiom of public transportation planning states that the greater the frequency, reliability, and convenience of the service, the greater the ridership. Considering the level of highway congestion, the perceived need for an additional Puget Sound region airport, and the urgent need to reduce greenhouse gas emissions by 2030, there is no reason to plan or design for less than the maximum achievable ridership.

Amtrak Connects US, the Amtrak vision for the state-supported corridors, page 40, presents the same service goal as that of the LRP, as does the 2019 Washington State Rail Plan..

The concept of the LRP, about 200 miles of 110 mph passenger-only track adjacent to the existing BNSF line, remains valid. The line changes discussed in the LRP are necessary for competitive rail service.

The details of the LRP, generally costs and ridership projections based on new conditions, have remained unexplored for 18 years. Population has increased more than projected in 2006. Climate change is expected to cause an even greater increase in the rate of population increase and the need for mode shift from highway to rail. There is a substantial chance that the changes will justify more service in round trips and service day.

The LRP was developed for tilting trains as recommended by the 1984 and 1992 High Speed Ground Transportation studies. WSDOT no longer has plans for tilting trains. Only two sets owned by Oregon remain in use in Amtrak *Cascades* service. Elimination of tilting trains will increase the number of alignment changes needed to maintain sustained 110 mph speed. (Appendix D page 69)

4. Congested Freight Rail to Effective Passenger Service

Starting With a Railroad That Couldn't Accommodate Effective Passenger Service . . . or Effective Freight Service

Burlington Northern (BN) railroad traffic had increased beyond its capacity limits by 1991. The line between Vancouver BC and Portland was 337 miles of parking lot. There were no passenger trains between Seattle and Vancouver BC. The prior service, discontinued in 1980, often took over five hours for the trip. There were three Amtrak trains each way between Seattle and Portland, all of which struggled to get through the congestion on time.

There was no way that any passenger service could be operated over the line until it functioned well for the freight traffic. All the involved parties understood that from the outset.

BN, needing to spread its capital budget over 27,000 miles of railroad, had a specific process to schedule and develop capital projects. The Pacific Northwest traffic problem was not sufficient in the system view to warrant a substantial capital program.

In 1991, in a effort to address system wide congestion, BN assembled a group of train dispatchers representing experience on every part of the system. During the kickoff meeting, each dispatching office was asked to describe the traffic and congestion problems on their district. One dispatcher from each office responded with a horror story of insufficient capacity and chaotic operation causing inability to move trains, which caused shortage of crews, which caused inability to move trains, which exacerbated the problem of Maintenance of Way crews getting time to work on the track. There was no way to determine the worst or the best areas. The representative for the Springfield, Missouri office observed 'I was going to talk about problems, but compared to y'all, we don't have any.'

With widespread meltdown, emphasis was placed on the highest revenue parts of the system, the coal train routes of Wyoming and Nebraska (where the traffic was 'money trains'). After the Santa Fe merger created BNSF, the emphasis for capital projects moved to improving the 'Transcon' route between Los Angeles and Chicago (Santa Fe's 'money trains'). However, BN/BNSF agreed to elevate Pacific Northwest projects that met the capital spending requirements and advance them ahead of others if possible. BN supplied management, engineering, and operations planning staff for the PNWRC program.

WSDOT agreed that fixing the freight problem first was the only way to achieve the desired passenger service.

After achieving a well-functioning railroad, improvements for faster trip times and more frequencies would follow.

Throughout the planning and implementation process, LRP methodology was to fix the freight problem, add service as made possible by freight projects, then add passenger-specific infrastructure for expanded and improved service.

The Master Agreement

BN/BNSF actively participated in the entire development process and agreed in principle to implementing the LRP in 2005, before the 2006 publication. The agreement anticipated program completion before June 30, 2023. Throughout 2021-2023, WSDOT denied that BNSF had agreed to implementing the LRP.

The map at right shows the BN route between Everett and Vancouver BC and the inability to operate trains in both directions efficiently. With the sidings unavailable because of inadequate length or stored freight cars, a train would need to pull off onto a branch line to clear the way for a train in the opposite direction then back out to go on its way. Trains frequently waited for an hour or more for an opposite direction train to arrive.

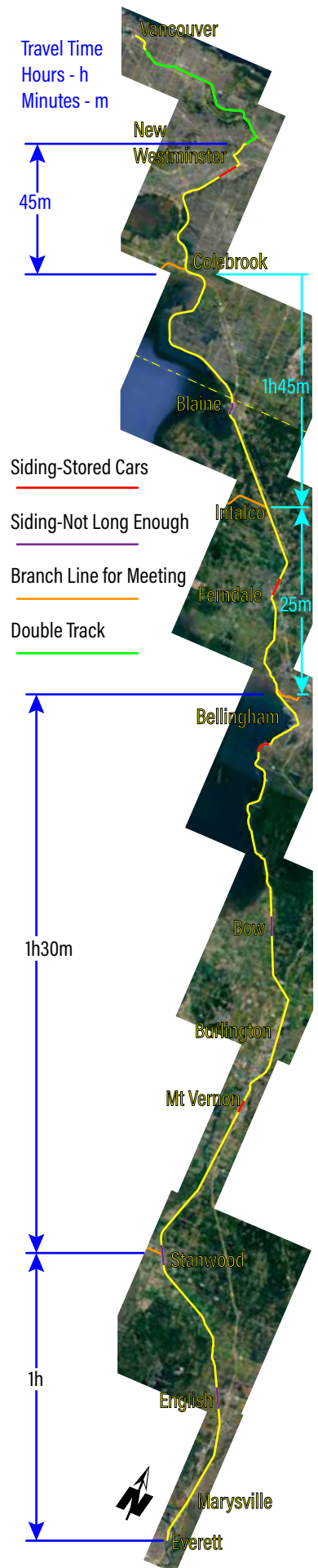

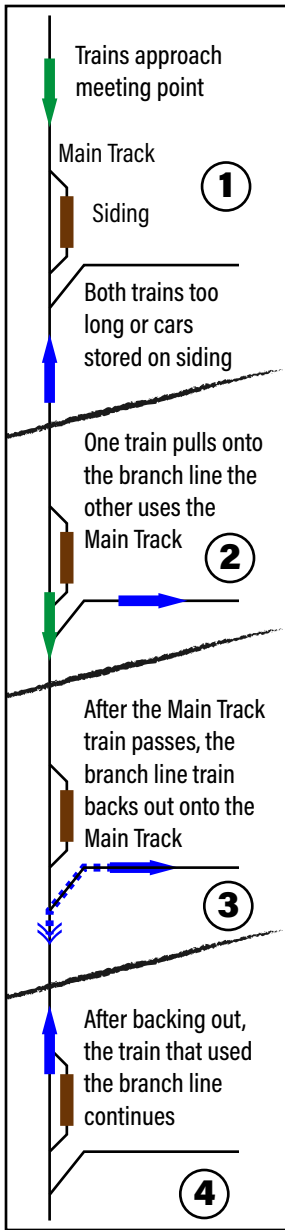

The Right Way and the Wrong Way to Operate a Single Track Railroad

By 1990, BN trains between Everett and Vancouver BC were operating as shown on the left. As shown on the map on the previous page, sidings were either not long enough to accommodate the length of trains being operated or were occupied with stored freight cars. Also shown in the previous page map are the long travel times between meeting points. The process of making the meet as shown at left would add another 30 or more minutes to the time spent waiting for the opposing train.

The diagram at right shows the correct way to operate a single track railroad. When the PNWRC program began, BN had experienced several years of the operation in the left diagram.

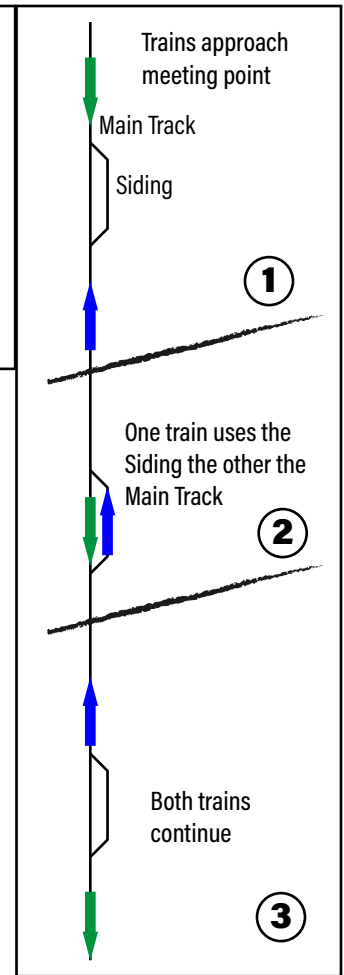

For Freight, 340 Miles of Horrendous Congestion and Delay

» Vancouver BC - Everett

In 1991, normal operation included trains pulling out on to branch lines at Colebrook BC, Custer, Bellingham, or Stanwood Washington to let the opposing train pass, then backing out and continuing on its way. Trains were delayed for hours by these maneuvers.

Municipal speed limits: Blaine 15 mph, Ferndale 40 mph, Bellingham 10 mph, Burlington 20 mph, Mt. Vernon 20 mph, Marysville 20 mph, exacerbated the congestion and delay.

Freight trains stopped on the main track at Blaine and White Rock for over an hour for customs inspection. Movement authority between Blaine and Bellingham was conveyed by verbal transmission of written instructions, a time-consuming process. The main track through Burlington bisected the yard, requiring long periods of the main track being blocked for switching operations.

Delta Yard in Everett was the base of operation for the Everett-Vancouver BC/Sumas trains. The yard was inadequate for the traffic, resulting in the main track being used as a yard track for hours at a time.

In 1991, BN was engaged in a Scheduled Railroad Program (in the European sense, not the current Class 1 railroad PSR program) in an attempt to fix congestion by maximizing infrastructure utilization. The Everett- Vancouver BC train schedules had been developed

but not yet implemented because of the lack of usable sidings. To minimize interference to the existing BN freight operation, the Amtrak schedules were developed for least interaction with freight trains, limiting the infrastructure projects needed for successful passenger train operation.

BN was operating eight through freight and several local freight trains per day. The through freight trains typically needed a second crew because of the 12 hour federal hours of service limit. A 100 mile trip generally took more than 12 hours. After the PNWRC infrastructure program was completed and before passenger service was restored, lack of operating discipline still caused freight trains to be delayed for hours. On time performance on the freight schedules that had been developed was around 10 percent.

» Everett - Nisqually

The Everett-Nisqually segment, particularly between Golden Gardens (Ballard) and Tacoma was congested and the source of extensive train delays.

The single track sections, about a mile between Golden Gardens (Ballard) and the Ballard drawbridge and between 23rd Avenue (north end of Interbay yard) and Galer Street (south end of Interbay Yard) were a source of constant congestion.

King Street Station was the location for substantial freight and passenger train delay. The location of the station on the west side of the line and the passenger train maintenance facility on the east side, connected by a series of hand throw, 10 mph switches caused delays because of the need to stop each time the route was changed.

The lack of signal system caused all trains to proceed prepared to stop within half the range of vision.

Between King Street Station and Tukwila, traffic control consisted of verbal instructions via radio. Switches between King Street Station and Tukwila were all hand throw except at Argo (Georgetown). BN trains parked on one of the main tracks at Lander Street, Argo, and South Seattle while setting out or picking up cars. UP trains blocked both BN main tracks at Argo for that process.

The Seattle municipal speed limit between Galer Street and Argo was 20 mph. The speed limit crossing Military Road was 40 mph.

The tracks between Tukwila and King Street station were configured for one way traffic on each track, but trains could move against the current of traffic on verbal authority of the dispatcher.

In the early 1980s, BN abandoned the track between Stacy Street Yard (behind the Starbucks [former Sears] building in SODO) and Bell Street on the waterfront, where there was a control tower with signals and power switches. All trains leaving to the north had to go south to a hand throw main line switch south of S Spokane Street. The train would stop at the switch, obtain permission, hand operate the switch, and move onto the main track, blocking S Spokane Street at Colorado Avenue S in the process. As the train pulled out at 10 mph, it also blocked S Spokane Street at 2nd Avenue S and S Horton Street. After pulling out completely, the brakeman or conductor had to restore the switches for main track movement then be driven up to the engine. The train might wait at King Street Station, blocking Royal Brougham, Holgate Street, and Lander Street or move to a location north of the tunnel, sometimes as far as Golden Gardens, north of Ballard, because the vehicle transporting the conductor was in the traffic jam caused by the train (below). A delay of 30 minutes or more waiting for the conductor was common, during which time the parked train was standing on a track needed by other trains, causing additional rail congestion.

The trip of 18 miles between Golden Gardens and Tukwila often took more than an hour.



- Single Track
- Double Track
- Yard Switching on Main Track
- No Passing-Trains follow in line
- No Passing and Yard Switching on Main Track

<p>Rail Congestion Causing Road Congestion Causing Rail Congestion</p> <p>— Train leaving Stacy Yard</p> <p>— Traffic jam caused by train</p>	<p>Train goes to Ballard to wait for traffic to clear and conductor to get to engine.</p> <p>50 min.</p> <p>Car with conductor can't get to engine</p>
<p>35 min.</p> <p>Car to take conductor to engine</p>	<p>50 min.</p> <p>Car with conductor can't get to engine</p>
<p>20 min.</p> <p>Car to take conductor to engine</p>	<p>45 min.</p> <p>Car to take conductor to engine</p>

The line between Tukwila and Tacoma was double track configured like a streetcar line, one track for northbound trains and one track for southbound trains. There was no way for a train to pass a preceding slower or stopped train. There was limited opportunity for trains to operate against the current of traffic around track maintenance, so either trains or maintenance was generally delayed during daylight hours.

Main tracks at Orillia, Auburn, and Sumner were often occupied by trains switching industrial customers.

At Reservation, the north end of Tacoma yard, the southbound main track was frequently needed for switching. The main tracks bisected the yard, so frequent switching movements crossed the main tracks between the two sets of yard tracks. Through freight trains stopped on one of the main tracks to set out or pick up cars.

There were municipal speed limits: Kent-40 mph, Auburn-40 mph, Sumner-40 mph, and Puyallup-30 mph. There was a 10 mph curve south of Tacoma yard, exacerbating the congestion at Tacoma.

The single track Ruston and Nelson Bennett tunnels further exacerbated the congestion in Tacoma, sometimes causing a freight train backup extending beyond Titlow, 10 miles from Tacoma, resulting in 14 miles of single track operation.

The 30 mile trip between Tacoma and Tukwila often took substantially more than an hour.

» *South of Nisqually*

Centralized Traffic Control (CTC) was in use between Nisqually and Vancouver. CTC involves the train dispatcher remotely controlling switches and signals to establish routes and movement authority. CTC allows trains to move in either direction on either main track at normal speed.

This characteristic allows a train to overtake a slower or stopped train and to pass by track maintenance using the adjacent track. The system provides great operational flexibility, but has a shortcoming. The flexibility is limited by the need for trains in the opposite direction to stop, allowing both tracks to be used by trains moving in the same direction. It works well when traffic is moderate and the distance between crossovers (an arrangement of turnouts that allows movement from a track to the adjacent track) is suitable for the traffic. It's like a heavily traveled two lane road. Even if passing is allowed, the constant traffic moving in the opposite direction prevents it. If there is no lane or pull off spot



for the slow vehicle, you're stuck in line. That describes the situation between Nisqually and Vancouver.

» *Centennial (Amtrak Olympia/Lacey station)*

The Centennial station is located on the east side of the line and has a passenger platform only on that side. There are three platform extension crossings between the two main tracks for use in case use of the west track cannot be avoided, not intended for normal use. A passenger train boarding and alighting passengers on the west track also occupies the east track because a train cannot use the east track while passengers are on or crossing it. Passenger trains in both directions had to use the east track for 13 miles between Nisqually and Plumb, often resulting in difficult traffic movement conditions and delays.

» *Centralia*

There is freight congestion at Centralia that was not anticipated throughout the LRP development. One or two trains a day would stop on the west main track to set out and pick up cars. The station location on the west side, adjacent to the yard could cause some conflict with trains setting out or picking up, but the greater traffic problem was the need for passenger trains to use the west track for six miles between Wabash and Centralia South for access to the station.

Freight traffic has increased and changed in nature, resulting in freight trains stopping on the west track in front of the Amtrak station several times a day.

» *Rocky Point - Kalama*

The segment between Ostrander and Milepost (MP) 111 (about three miles south of Kalama) was occupied for about 12 hours a day by trains stopped to set out or pick up cars or trains waiting their turn. During part of that time, the backup extended between MP 85 (north of Castle Rock) and Ridgefield, 37 miles. During those hours, there was single track operation, with trains not destined for the Rocky Point-Kalama congestion waiting for opposite direction trains. The main track switch at the north end of Longview Jct. yard and all the main track switches at Kalama were hand throw, adding to the delay of a train entering or leaving a main track and causing collateral delays to other trains.

» *Vancouver*

The Vancouver yard was designed for use by Seattle-Portland and Vancouver-Pasco trains. The advent of a large volume of Seattle/Tacoma/Longview/Kalama - Pasco trains after the merger that created Burlington Northern from Northern Pacific, Great Northern (both Settle - Portland) and Spokane Portland and Seattle (Portland - Pasco) railroads caused substantial congestion at Vancouver. Yard switching was substantially interrupted for each train moving between the Pasco and Seattle routes. Trains waiting their turn on the connecting track would block a main track, causing single track operation and resulting congestion for other trains.

» *Portland*

The ten miles between Vancouver and Portland were known as 'The Terrible Ten' because of the congestion and delays. The two tracks were configured for single-direction traffic, one northbound, one southbound. There was no opportunity for overtaking. Trains regularly stopped on the main tracks at North Portland Jct., East St. Johns, Willbridge, and Lake Yard to set out or pick up cars. An approaching Amtrak or important freight train could tie up operation for long periods of time because of the inability to pass stopped trains. Trains that had work at these stations would be held at a distant point until the track was available without interfering with other trains.

Figuring Out What to Fix and How

» *Capacity*

Railroad capacity is determined by the travel time over the segment that can be occupied by only one train and has the greatest travel time. That is the limiting segment.

If trains on the line travel at a variety of speeds, the time occupying the limiting segment will also vary. An accurate determination of capacity depends upon knowing the trains that will be operated, the speed, and when they run.

» *Analysis*

Before solutions can be developed, analysis must be performed. Information developed by the analysis is the basis for developing effective solutions. PNWRC projects were developed through an extensive analysis program.

→ *Simulation*

Simulation is the most widely used rail infrastructure analysis method in the US. It involves the use of special pur-

pose software that is intended to replicate railroad operations. A detailed database of infrastructure and trains is developed for the area and traffic to be simulated. The program calculates the movement of every train at generally one second intervals. The program manages traffic in a way intended to simulate the action of a train dispatcher managing traffic on the rail line being analyzed. The depiction is not necessarily accurate.

The program is operated for a series of simulated days, perhaps a week, sometimes as much as a month. Train movements are randomized, in an attempt to replicate the random operation of a typical US railroad. The program tracks the miles traveled by the simulated trains and the minutes of delay the trains received. This figure, minutes of delay per 100 train miles, is used to determine infrastructure adequacy. An 'acceptable' amount of delay minutes per hundred train miles is assigned. Another common measurement of simulation output is delay ratio, the ratio of the minutes of delay to the total simulated minutes. There is no scientific method to determine 'acceptable.' It is arbitrary.

For this analysis, delay is defined as any time that the train is unable to operate at the maximum allowed speed for the train. That definition can lead to misleading results and a properly constructed timetable of schedules includes the time that trains are stopped as conflict resolution with other trains. That time is considered waiting time (an intended stop) in railroad scheduling throughout the rest of the world, not counted as delay.

The typical procedure is heuristic (trial and error, rule of thumb or an educated guess), trying an infrastructure solution and re-running the simulation until an acceptable result is achieved. That method may not achieve a solution that is effective in everyday operation and may not provide the desired level of reliability.

→ Analytical

An analytical method involves detailed individual analysis of trains, the relationship of trains to each other in the system, the factors causing congestion and delay, and a method to address those factors.

→ Analytical-Simulation Method: Joint WSDOT-BNSF Analysis

The railroad industry does not trust 'outsiders' to determine what they need. BNSF, Amtrak, and WSDOT developed the LRP jointly. Simulation was used to test analytical solutions instead of developing heuristic solutions. The procedure involved WSDOT and BNSF jointly developing and checking the input data. BNSF operated the simulation on Rail Traffic Controller software they owned. Simulation output data was then analyzed jointly by WSDOT and BNSF.

The first significant exercise involved the Kalama- Longview Jct.-Rocky Point area. BNSF insisted that they must be 'kept whole' in the development of the passenger program. The procedure for such testing is start with a simulation of the Base Case, the current traffic, to determine the current delay ratio. Thereafter, increased passenger service improvements must maintain that delay ratio.

Repeated simulation of variations on current traffic could not establish a delay ratio that BNSF found even close to acceptable. Subsequent attempts with the freight traffic increase BNSF expected and no additional passenger service resulted in not only worse delay ratio but the inability of the software to run all of the trains even with extreme delays.

That work set the basis for the rest of LRP development. It was decided that WSDOT would fix freight problems in exchange for BNSF participating in and accepting the full program as proposed.

→ Hose Analysis

Railroad traffic does not act like a fluid as does highway traffic; however railroad capacity is similar to the capacity of a hose. If a hose is made up of segments of different diameter, the capacity of the smallest diameter segment determines the capacity of the hose. To increase the capacity of the hose, the smallest diameter segment must be replaced. Replacing other segments with a larger diameter hose will not increase the capacity of the hose.

Hose analysis involves iterative searches for the capacity limiting segments, identifying them in

Hose Analysis

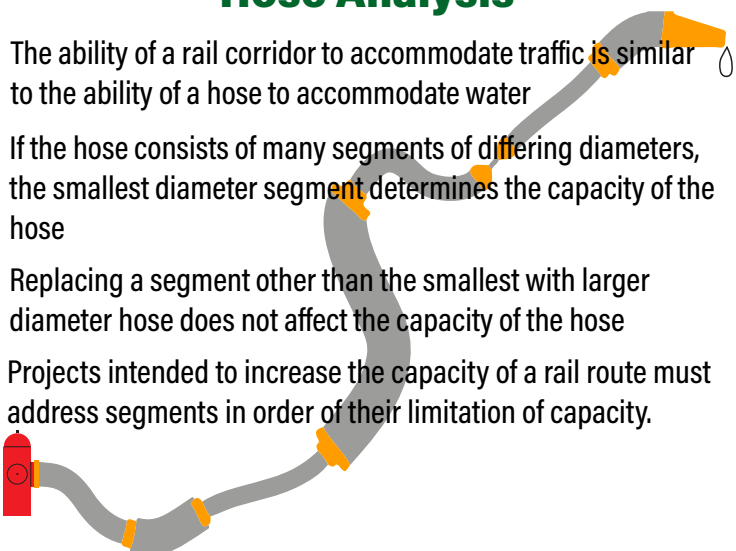

- The ability of a rail corridor to accommodate traffic is similar to the ability of a hose to accommodate water
- If the hose consists of many segments of differing diameters, the smallest diameter segment determines the capacity of the hose
- Replacing a segment other than the smallest with larger diameter hose does not affect the capacity of the hose
- Projects intended to increase the capacity of a rail route must address segments in order of their limitation of capacity.

Timetable	Seattle-Portland Trains	Travel Time	Seattle-Vancouver BC Trains	Travel Time
A	4	3h25m	2*	3h55m
B	5	3h20m	2	3h30m
C	8	3h	3	3h25m
F	10	2h55m	3	3h25m
E	12	2h45m	3	3h25m
F	13	2h30m	4	2h37m
Fa	14	2h30m	5	2h37m
* One Seattle-Vancouver and One Seattle-Bellingham				

Table 2. LRP Phases

the order of the severity of congestion. Hose analysis was conducted iteratively over segments of the entire route, establishing the original capacity and the capacity with added trains and the capacity after adding projects.

The development of the Amtrak Cascades program was divided into six phases, identified by six sets of projects and the accompanying timetable, identified as A through F (Table 2).

The first priority of the PNWRC program had to be fixing the BN/BNSF freight operation problems

in order to build a functional railroad on which to superimpose passenger service. Those were addressed in the first three phases, Timetables A, B, and C of the plan. The later stages would concentrate on projects with mostly passenger benefit such as dedicated 110 mph passenger tracks. Almost all the improvements to date have had a primary freight benefit. Little has been done exclusively for passenger benefit.

Fixing Freight Problems Makes Room for Amtrak Cascades

This section describes the solutions developed in the LRP geographically in the manner of the problem description. The order of construction in the LRP is in the order of need and effective, not geographical. In the following, some of the projects have been completed, some have been partially completed.

» Vancouver BC – Everett

The first PNWRC improvement program restored Seattle – Vancouver BC service. The program included:

- a new siding, subsequent second siding, and Customs facility south of Blaine (railroad location name Swift),
- extending the sidings at Ferndale, Bow, and English,
- re-configuring the Burlington yard to avoid conflict between switching and main line trains,
- Centralized Traffic Control (CTC) between Blaine and South Bellingham and at Burlington,
- a yard at Cherry Point to accommodate the cars that had been stored in the sidings,
- elimination of municipal speed limits in Blaine, Bellingham, Burlington, Mt Vernon, and Marysville, resulting in a freight train travel time reduction of over an hour,

All local management was instructed to ensure that freight trains operated as described in the operating plan and that passenger trains that were responsible for the new infrastructure would not be delayed. **On the first day of the restored Seattle - Vancouver BC service, hours of service relief of freight train crews became zero and on time performance of freight trains became 100 percent, the result of the adequate infrastructure furnished by the PNWRC program and the management requirement for disciplined operation of freight service.**

By the time of the second Vancouver BC train in 2009, BNSF traffic had grown and WSDOT lengthened sidings at Mt. Vernon and Stanwood to accommodate the additional freight traffic and the new passenger train.

BNSF has subsequently made improvements to accommodate the substantial growth of freight traffic between Everett and Blaine.

» Everett – Tacoma – Sound Transit improves the railroad to accommodate Sounder and Amtrak Cascades

Sounder commuter service was developed beginning in 1991, concurrently with the PNWRC program. Sounder was in the same position as the PNWRC program. It was impossible to add reliable commuter train service to the existing infrastructure. The Sounder program was developed simultaneously and in concert with PNWRC program development. Sound Transit and WSDOT agreed that Sound Transit would build infrastructure needed by both services and design to accommodate future Amtrak Cascades needs.

Between Ballard and Tukwila, freight facilities are generally on the west side of the line, so the track arrange-

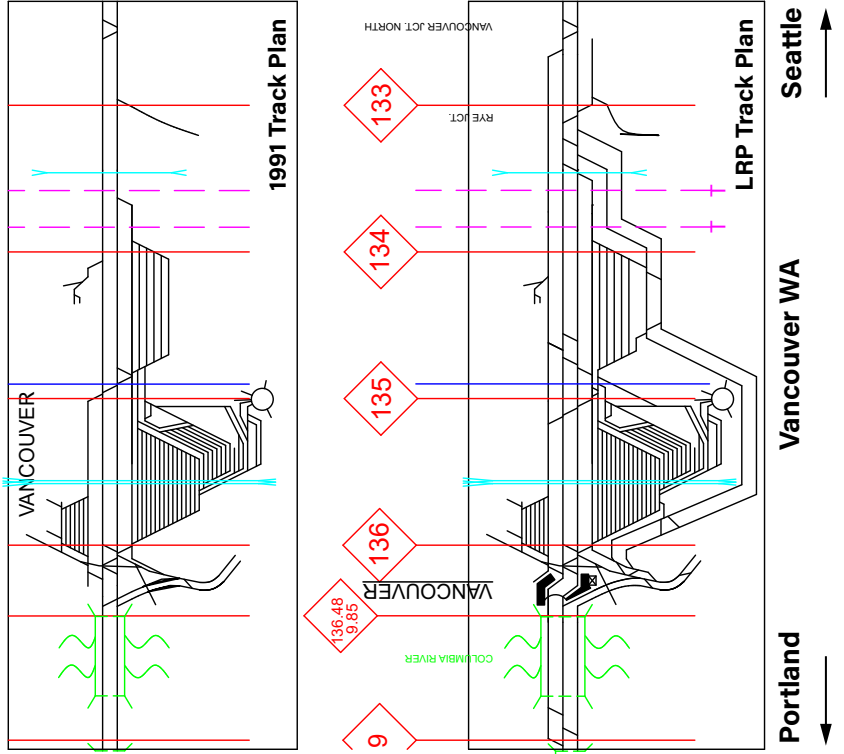
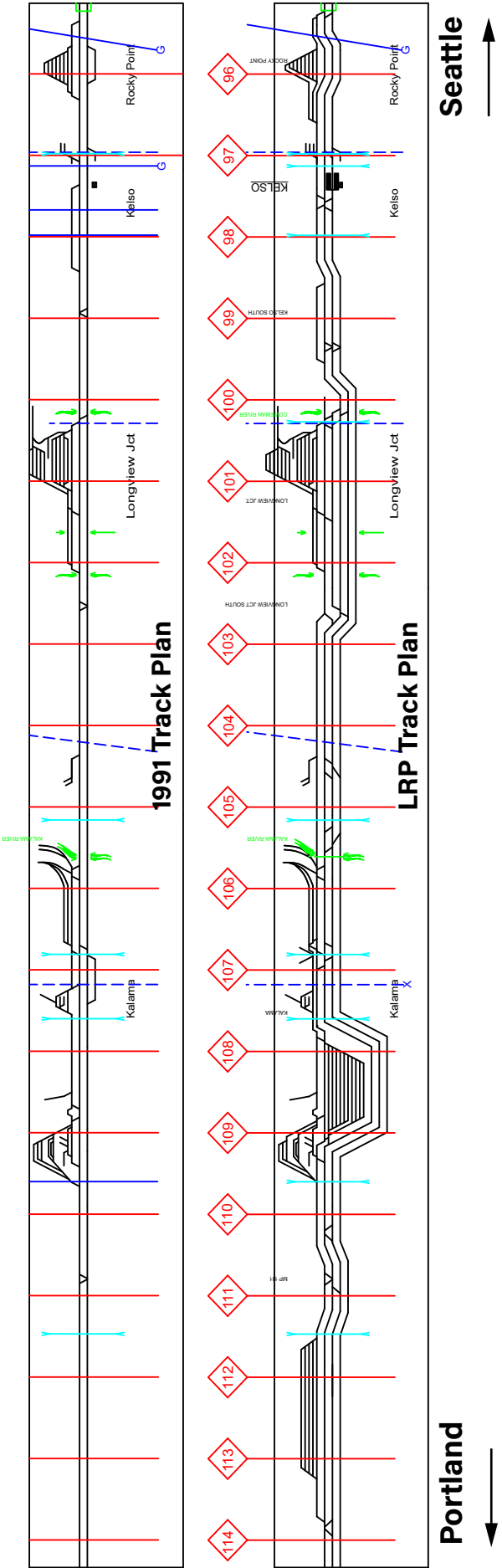

Above: The 1991 existing and LRP track arrangement for Vancouver

Left: The 1991 existing and LRP track arrangement for the Kelso-Martin's Bluff project.

Below: Vancouver Amtrak station and traffic patterns.

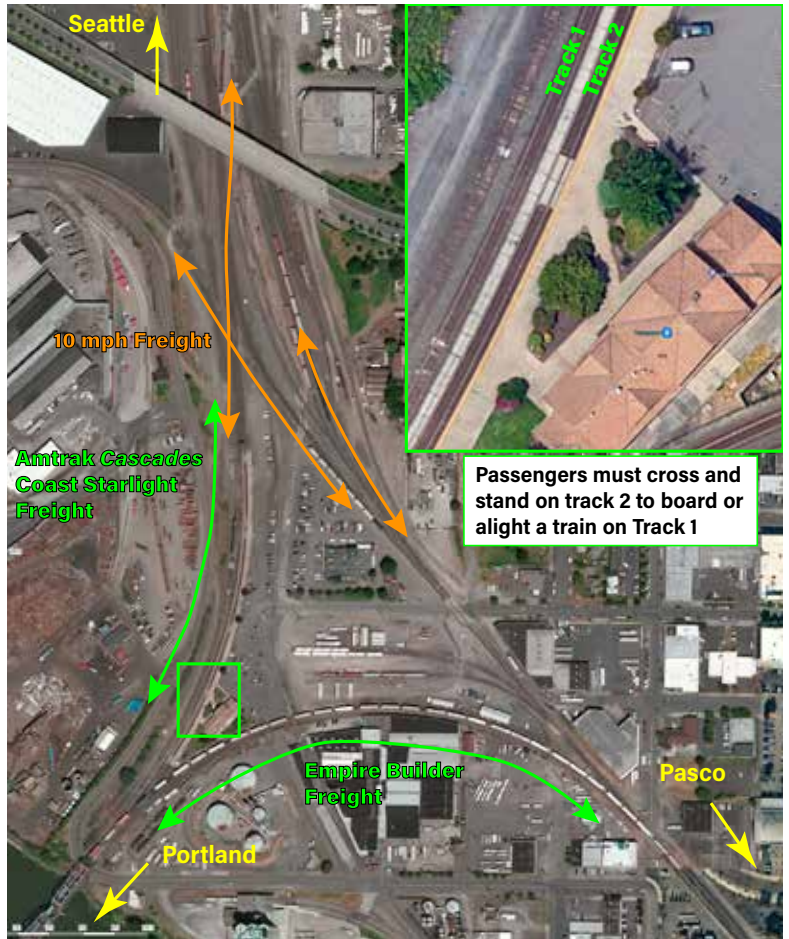

ment separated nonstop traffic (passenger trains and freight trains passing through without stopping) from freight trains stopping for pickup, setout, or switching. A freight track west of the existing main tracks allowed freight trains leaving the Seattle International Gateway yard at 10 mph without conflicting with passenger and freight trains passing by.

The Sounder program included:

- a second main track between Golden Gardens, north of Ballard, and Galer Street in Seattle,
- a third main track between King Street Station and Kent,
- a freight train running (secondary) track between Argo (Georgetown) and South Seattle,
- yard tracks for BN and UP between Argo and Military Road,
- additional tracks for South Seattle Yard,
- a third main track between Thomas (S 277th Street) and Ellingson Road (south of Auburn),
- a siding between Auburn and Ellingson Road,
- CTC between Ballard and Ruston,
- re-configured Tacoma yard to eliminate conflict between freight and passenger service,
- third main track adjacent to Tacoma Yard,
- elimination of municipal speed limits in Seattle, Kent, Auburn, Sumner, and Puyallup, reducing freight train travel time by over 30 minutes.
- increase the speed of the 'Head of Bay' curve in Tacoma from 10 mph to 30 mph.

A joint Amtrak-WSDOT project relocated the BN main tracks between Royal Brougham and Lander Street in Seattle to eliminate freight-passenger conflict at King Street Station.

The improvements resulted in free-flowing freight traffic and the ability to add the passenger service while accomplishing improved freight service.

» *Freight Congestion South of Tacoma*

Moving Amtrak trains to the Point Defiance Bypass between TR Jct. (the connection with the BNSF main tracks north of Tacoma) and Nisqually removed passenger operations from the BNSF yard, allowing free use of both tracks for freight trains.

Freight activity, trains stopping to set out, pick up, or switch, occurs on the west side of the main lines at Centralia, Rocky Point (no longer active but was when the LRP was developed), Longview Jct. and Kalama. The track arrangement at those places was configured for passenger operation on the east side of the right of way and freight on the west side.

At Vancouver, and between Vancouver and Portland, freight activity is substantial east and west of the main tracks. The LRP concept was to provide separate tracks for freight activity where possible and provide substantial flexibility in main track operation.

» *Centennial (Amtrak Olympia/Lacey station)*

Traffic between Centralia and Nisqually was facilitated by the construction of two crossovers at Centennial, eliminating the need to change the flow of traffic between left-hand and right-hand running several times a day. They are located immediately north and south of the platform to allow passenger trains to arrive or leave at the station platform from or to either track. The crossover switches have a 50 mph speed limit and are located at the point where a passenger train stopping at Centennial will be at 50 mph.

» *Centralia*

Centralia has the only passenger station on the west side of the main tracks. The yard and connection to the Gray's Harbor line (now the Puget

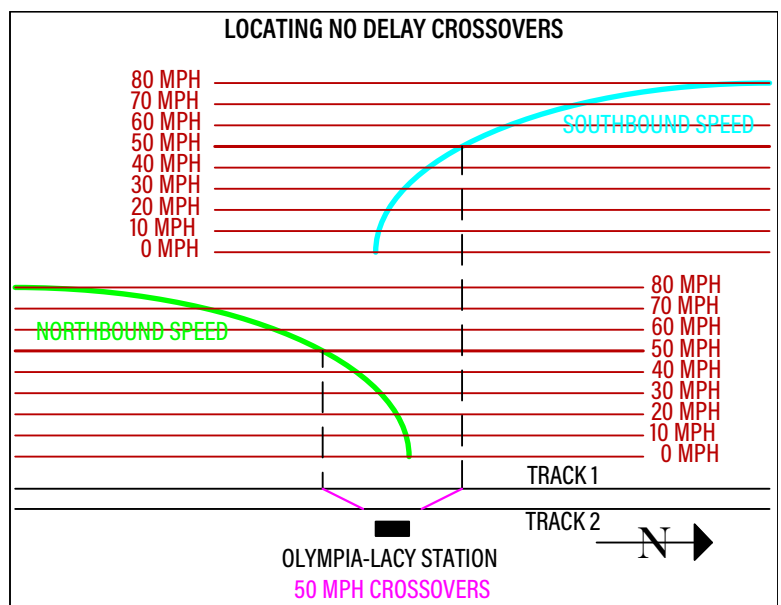

Sound & Pacific Railroad) are immediately north of the station. There was little freight activity at Centralia as the LRP was being developed, but passenger trains using the west track, conflicting with freight operation, was considered inappropriate as a long term solution. The LRP includes a passenger track and platform on the east side of the line.

» *Rocky Point-Kalama*

The LRP solution to the high degree of congestion in this area was to construct additional track on the west side of the main tracks for freight operation and keep passenger traffic on the east side of the line to avoid conflict with freight operation. Extensive freight trackage was added to compress the miles-long waiting lines and allow several trains to work simultaneously instead of waiting in line. The east track is the 90-110 mph (depending upon location) passenger train track.

» *Vancouver*

Vancouver posed a difficult problem. The intensive freight activity is east of the main tracks, but there is also a substantial amount on the west side. There is a junction with the Vancouver-Pasco line east of the main tracks and south of the Amtrak station. There is also a 10 mph freight track between the yard and the Pasco line on the east side and the Port of Vancouver on the west side. The Amtrak station is east of the main tracks. There is no platform on the west side.

» *Portland*

The entire line between Vancouver and Portland is constrained by development and geography. Faster connections to Union Pacific (UP) and an additional connecting track to UP addressed the substantial problem of UP trains entering and leaving the main tracks at 10 mph and the UP single track operation.

A freight main track and crossovers at the Willamette River addressed the East St. Johns area congestion.

Centralized Traffic Control, higher speed turnouts and crossovers and a short segment of freight-only main track addressed the freight congestion at Willbridge and Lake Yard.

However, the amount of track that could be economically constructed did not address the need for freight trains to stop on one of the main tracks for setout, pickup, or switching. That element was addressed by developing a timetable that did not involve passenger trains being scheduled to meet between Vancouver and Portland, leaving one of the main tracks always available for freight trains.

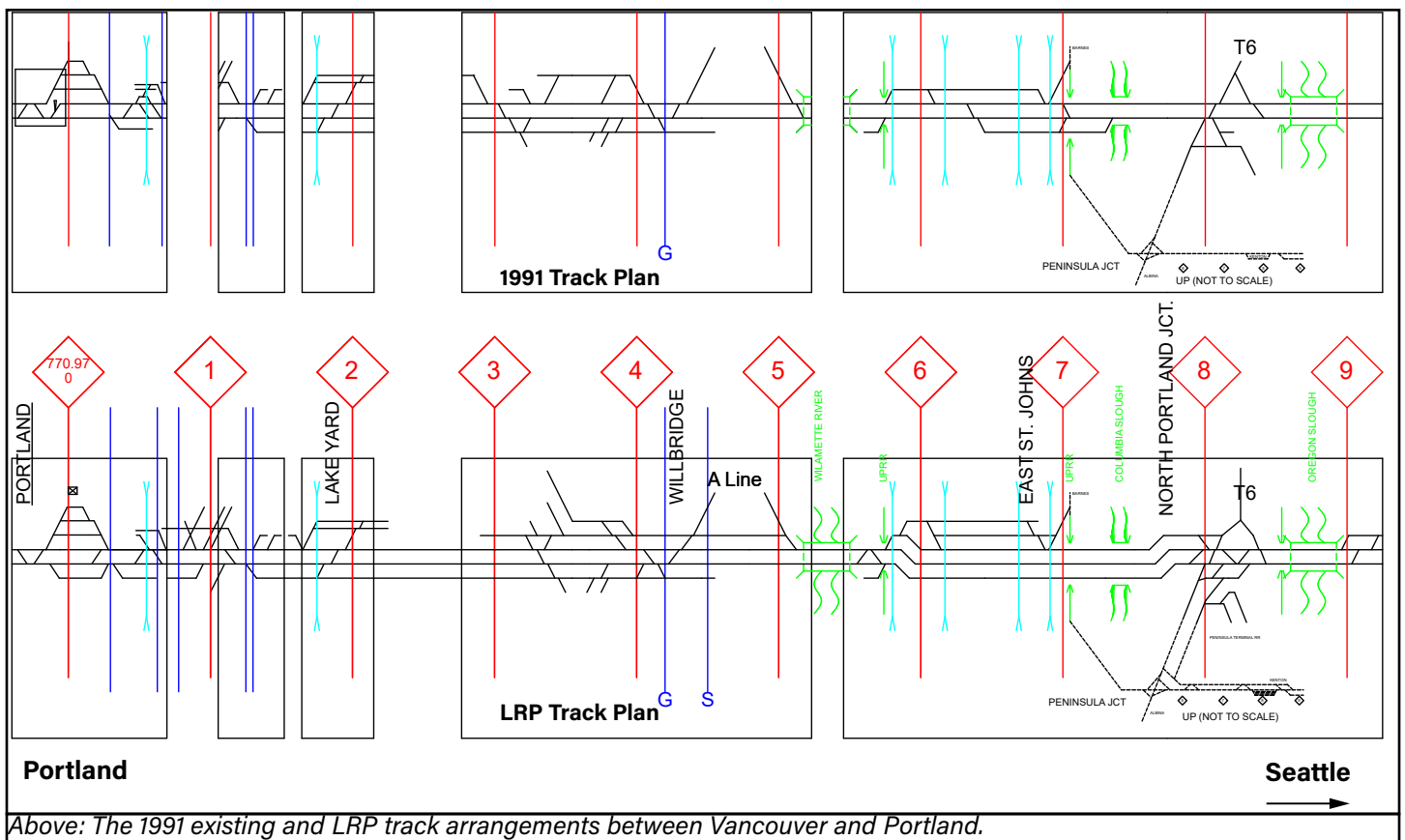

Above: The 1991 existing and LRP track arrangements between Vancouver and Portland.

Adding Infrastructure for Passenger Trains

Fixing the freight problems with appropriate infrastructure provided a foundation for passenger service. The WS-DOT team that was assigned to design the LRP met that requirement. The LRP established a goal of 13 round trips between Seattle and Portland in two hours thirty minutes and four between Seattle and Vancouver BC in two hours forty-five minutes as directed by the legislature. That service would require extensive new passenger train infrastructure.

The first step was to determine the infrastructure needed to restore Seattle - Vancouver service immediately. That was included fixing the freight aspect of the program.

The LRP was divided into six phases of implementation (Table 2 page 19). The first three addressed freight congestion and added passenger service that those improvements could accommodate. The last three phases were generally passenger improvements to reduce travel time.

Thereafter, the LRP process involved first developing the infrastructure requirements for the goal service. Planning assumed that between Portland and Vancouver, Tacoma and Marysville, Mt Vernon and Burlington, and through Bellingham, the maximum speed for Amtrak *Cascades* trains would be 79 mph to limit the amount of overtaking and associated additional infrastructure in these constrained areas.

Tolerances allowed in various measurements of track, such as the distance between the rails and deviation from level measured across the rails, become smaller as speed increases. For example, the rails must be between 4'8" and 4'9 1/2" apart for 79 mph track and between 4'8" and 4' 9 1/4" for 110 mph track.

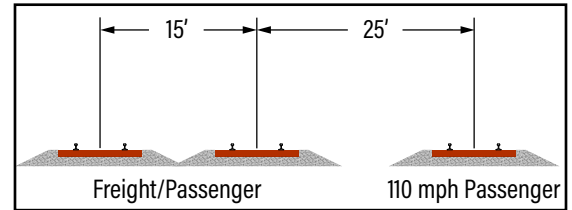

US freight trains are very heavy, about 37 tons per axle. Passenger trains typically weigh about 20 tons per axle. The effect of the wheels on the track is related to weight and speed. Each axle of a grain train moving 35 mph has the same effect on the track as a passenger train moving 110 mph. However, a six car passenger train has 28 axles. A 110 car grain train has about 458 axles, depending upon the number of locomotives. Therefore, all 110 mph track is used exclusively for passenger trains to substantially reduce the required maintenance intensity and frequency. BNSF agreed to the 110 mph tracks at a center-to-center distance of 25 feet from the existing tracks.

Analysis determined the order of construction and service improvements. A set of projects would provide the capacity for additional trains at the most constrained part of the line. The PNWRC program identified six sets of projects (phases) addressing six major constraints to additional and faster passenger trains. The first three addressed freight congestion and added service that those improvements could accommodate. The last three phases were generally passenger improvements to reduce travel time. Each of the six phases were developed to accommodate a specific number of trains, times of day, and travel times. They were named Timetable A through F. (Table 2 page 19)

After the full development of the service directed by the Legislature, further work determined that a service of 14 Seattle - Portland and 5 Seattle - Vancouver BC trains cost less to operate than the 13 and 4 service. It was includ-

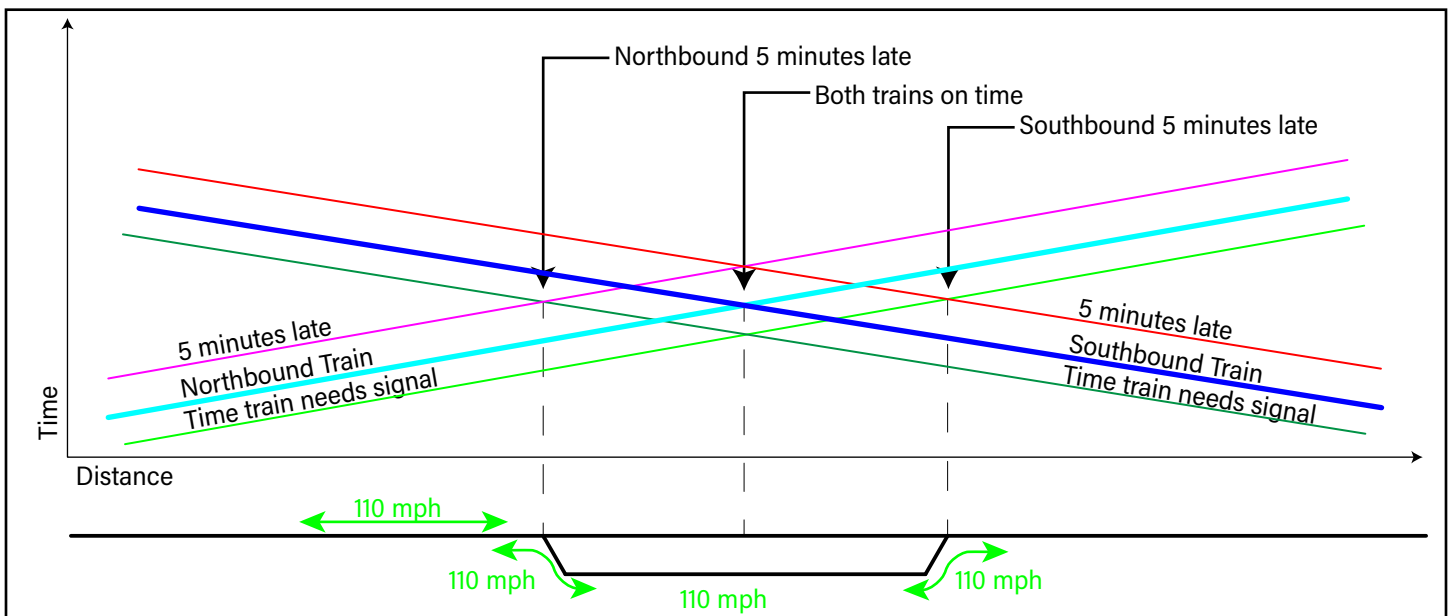

ed in the LRP as Timetable F Revision A (Table 2 page 19).

In the interest of economy, the passenger-exclusive track was designed to be single track operation with segments of second passenger track at meeting points. Hourly headway provides passenger train meets at the same place every hour resulting in low infrastructure requirements. Siding location was set with the center of the siding at the scheduled meeting point. The length was determined by extending in both directions to the point at which one train five minutes late plus the distance that the on time train does not get a signal indication to slow down.

» *Maximum Speed - Why 110?*

At the outset, in designing the LRP, the maximum speed was expected to be 125 mph. After extensive testing, the passenger-exclusive tracks with a 110 mph maximum speed met the travel time requirement most economically. A test of 125 mph maximum speed determined that the time saving was only three minutes and additional cost was substantial.

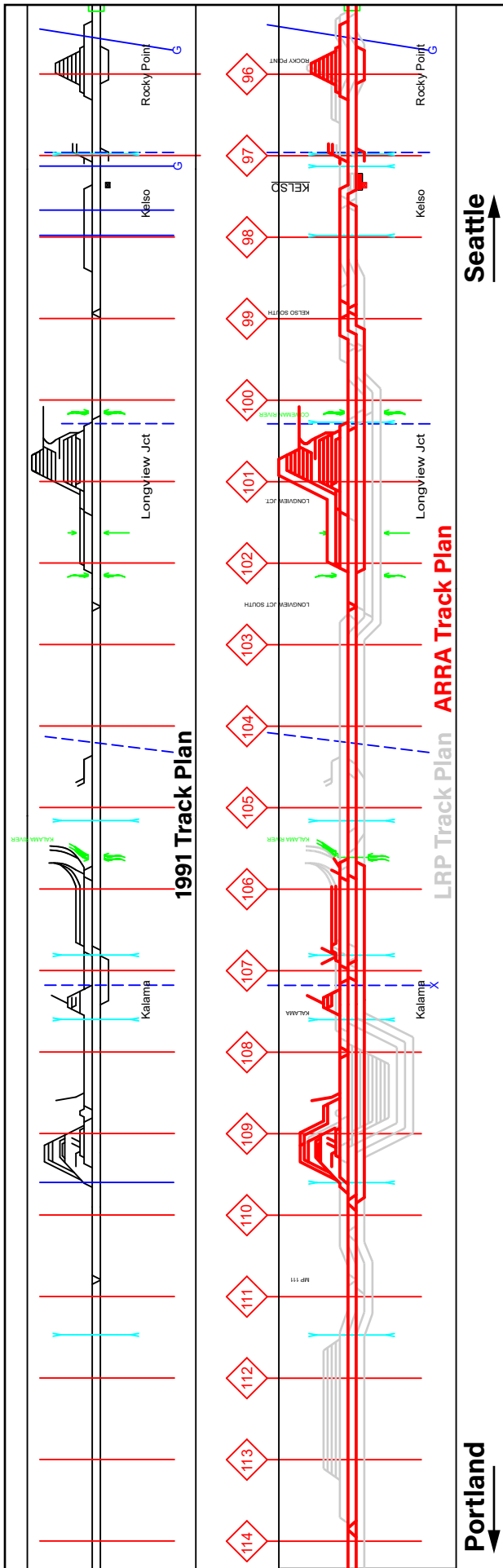

5. The 2010 American Recovery and Rehabilitation Act Improvements

This is a critical time for Amtrak *Cascades* service development. The 2010 American Recovery and Reinvestment Act (ARRA) grant provided most of the LRP-planned freight congestion relief. In exchange, Amtrak *Cascades* service was increased to six round trips per day between Seattle and Portland with 3 hour 20 minute travel time. The contract among WSDOT, BNSF, and FRA guaranteed reliability of 88 percent.

However, reliability has been less than 60 percent since the new service initiated in 2017, although the full six train schedule was not initiated until 2024. Current travel time is 3 hours 25 minutes.

Some of the ARRA projects were located north of Everett, reducing the effect of Amtrak *Cascades* trains on freight. Extensive track reconfiguration and CTC at King Street Station were a passenger-exclusive benefit. There were projects all along the corridor replacing turnouts with another type that requires less maintenance.

The biggest ARRA projects addressed the freight congestion problems in the Tacoma, Rocky Point - Kalama area and the Vancouver - Portland area.

» Rocky Point-Kalama

The 2010 ARRA grant work in this area was an abbreviated arrangement of the LRP arrangement (diagrams at left). There is no passenger-exclusive track. The two segments of third main track are incorrectly configured and located to be considered tracks intended for passenger trains.

The ARRA grant project included power switches and a cross-over between main tracks at the north end of Longview Jct. yard to facilitate freight movement, a freight running track west of the Longview Jct. yard, a freight running track the length of the Port of Kalama area (four miles) and numerous controlled

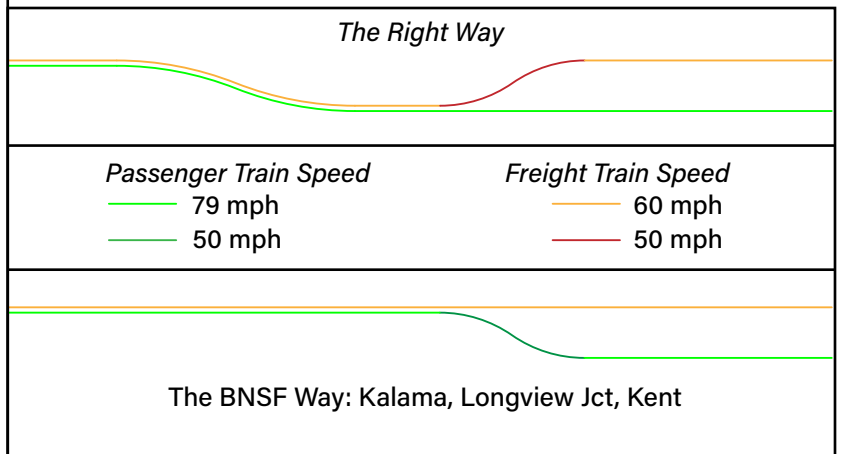

Above: A track that is intended for passenger trains should not be arranged to require slowing for a turnout as third main tracks was constructed at Kalama, Longview Jct, and Kent.

Left: The upper diagram is the original 1991 situation. The lower diagram shows the LRP arrangement in gray and the arrangement constructed by the 2010 ARRA funding in red.

crossovers between the main tracks and between the west main and the freight running track, and a power switch at the connection into the Kalama Export and Temco grain terminals. (Appendix A page 51)

The ARRA grant project constructed two four mile long segments of third main track east of the two current main tracks. They have limited utility for passenger trains because the configuration requires passenger trains to slow from 79 mph to 50 mph three times in eight miles. They have limited utility for freight trains because all the local freight operation occurs on the west side of the line.

The new track adjacent to Longview Jct. yard was intended in the Long Range Plan to deviate from the existing alignment sufficiently to allow 90 mph operation. Instead, the track was constructed adjacent to the existing alignment, limiting passenger trains to 60 mph in its general use configuration. As a passenger-exclusive track the maximum speed could be 72 mph without tilting trains or 82 mph with tilting trains. However, WSDOT has decided that tilting trains will not be used in Amtrak Cascades service.

Although these projects were not developed for optimum passenger operation, they have eliminated the causes of the freight congestion of 1991. The magnitude of the ARRA projects for this area is substantially less than the arrangement in the LRP, but that was BNSF's choice. BNSF stated that they were changing operating practices to make that amount of train storage track unnecessary. They stated that they would no longer provide track to stage arriving trains pending the consignee's order. Consignees would be expected to accept every train on arrival without delay or furnish their own staging tracks.

» *Vancouver*

The ARRA grant project at Vancouver relieved the 1991 freight congestion by constructing a connecting track between the Seattle and Pasco routes, east of the yard, reconfiguring the south end of the yard to create a second Seattle-Pasco connecting track that does not interfere with yard operation, a 9,000 foot siding west of the main tracks, and several new power crossovers and yard switches.

An additional part of the ARRA project that was not part of the LRP is a Port of Vancouver bypass track that connects Port of Vancouver to the BNSF Vancouver - Pasco route, crossing under the BNSF Seattle - Portland route, eliminating the need for this traffic to stop yard operations and Seattle - Portland route traffic while crossing at 10 mph.

The arrangement performs many of the intended functions of the LRP arrangement. There are two Seattle Route-Pasco Route yard bypass tracks, but only one allows 35 mph entry-exit to the Seattle

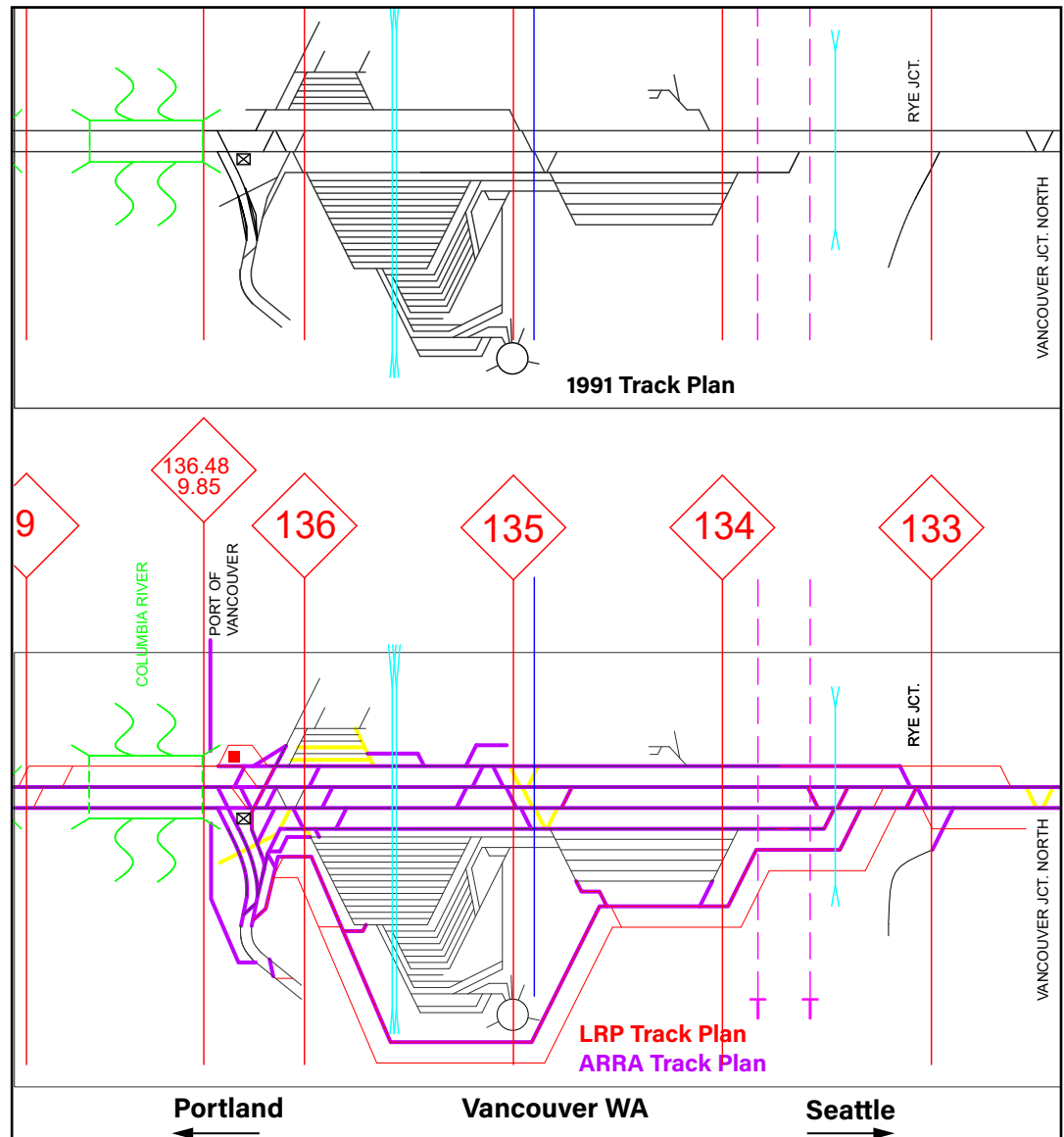

In the lower diagram, tracks in red were changes in the LRP. Tracks in purple were constructed with the 2010 ARRA grant. Tracks in yellow were removed during ARRA grant construction.

line. The other is 10 mph track. When the LRP plan was developed, sufficient vacant property existed east of the yard to accommodate two 35 mph yard bypass tracks. However, although the need for the property was known, WSDOT was not allowed to acquire it until there was an approved and funded project. The land was sold and developed.

The main tracks for movement between Portland and the Pasco line were reconfigured to raise the speed limit from 10 mph to 25 mph.

» *Portland*

A State of Oregon project installed CTC between Vancouver and the north end of Portland Union Station in 2000, eliminating single-file operation and allowing the use of both tracks in either direction for passing of stopped trains. CTC did not solve all the freight congestion problems, but it was a significant improvement. It also included power crossovers in Portland, eliminating the need for passenger trains to stop to hand throw crossovers when entering and leaving Portland Union Station.

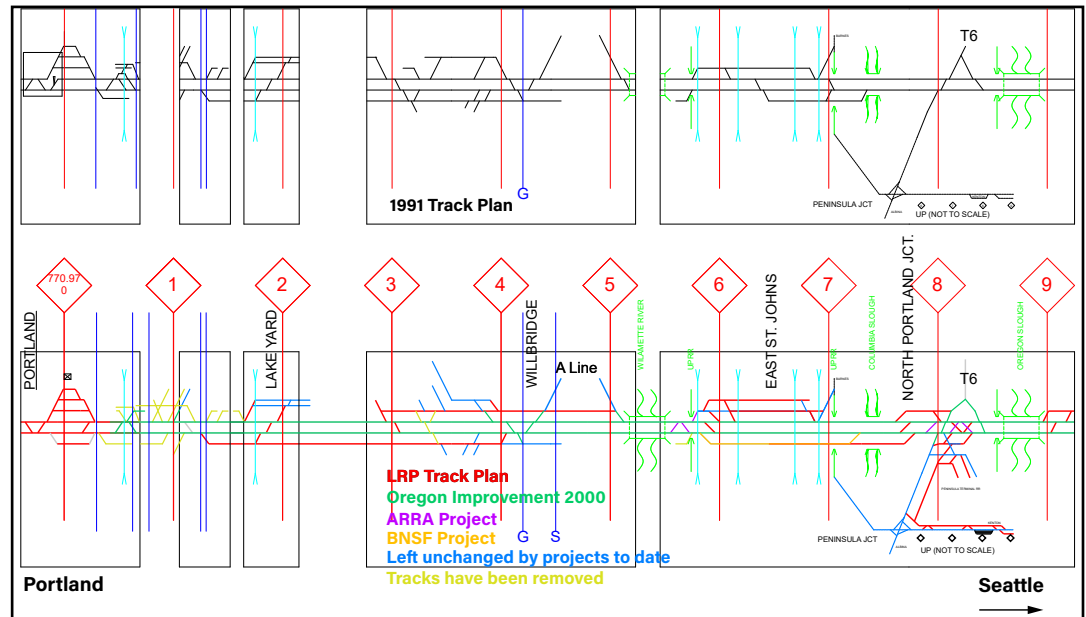

BNSF constructed a 7,500 siding at East St. Johns, significantly improving the freight congestion problem.

The ARRA grant constructed 30 mph crossovers supplementing the existing 10 mph crossovers on the north bank of the Willamette River, the same speed limit as the adjacent drawbridge, and 35 mph crossovers at North Portland Jct. These crossovers eliminated the need to keep passenger trains on the same track the entire distance between Vancouver and Portland, one of the sources of freight delay.

The significant freight improvement project remaining is the higher speed and second main track BNSF-UP connection between North Portland Jct. and Kenton on UP.



6. Long Range Plan as a Service Development Plan

Corridor ID and Service Development Plan

The Federal Railroad Administration established the Corridor Identification and Development Program (CID) as a framework for distributing grant funds. The program intends to ensure that programs have a fully executable plan for complete service rather than haphazardly spending money on projects that have no effective outcome.

WSDOT has declared that the LRP is obsolete and was an exercise never intended for development. Based on that claim, WSDOT has applied for the Federal Railroad Administration Corridor ID (CID) program. The first step to obtaining grants under this program is to submit an SDP for the program that is to be considered for a grant.

FRA established requirements for Service Development Plans. A service plan is a basic description: We want to run this many trains a day between Here and There at a certain headway/interval. A Service Development Plan (SDP) is a detailed assessment of the effectiveness and feasibility of the service plan and how it will be implemented. The culmination of that process is a Tier I Environmental Impact Statement (EIS) as prescribed in the National Environmental Policy Act (NEPA). A Tier I EIS examines broad issues such as general location, mode choice, air quality, and land use implications of major alternatives. As site-specific projects are identified, each project will have a separate Tier II EA/EIS. Tier I EIS specifies decisions which must be resolved in Tier II documents.

LRP took place over 15 years, met all the current requirements of an SDP, and was accepted by Federal Railroad Administration and Federal Highway Administration as a Tier I EIS for the program.

The LRP as an SDP

LRP qualifies as a Service Development Plan under current FRA Requirements. The requirements are listed below with citations from the LRP.

1. Rationale, Goals, and Objectives

Long Range Plan for Amtrak Cascades 2006, Chapters 1-4

Long Range Plan for Amtrak Cascades 2006, Appendix A

Amtrak Cascades Operating and Infrastructure Plan Technical Report VOLUME 1 Chapter 1

2. Identification of Alternatives

Long Range Plan for Amtrak Cascades 2006, Chapter 9

Long Range Plan for Amtrak Cascades 2006, Appendix B

Amtrak Cascades Operating and Infrastructure Plan Technical Report VOLUME 1 Appendix A

Amtrak Cascades Operating and Infrastructure Plan Technical Report VOLUME 1 Appendix L

Long Range Plan for Amtrak Cascades 2006, Appendix E

Amtrak Cascades Operating and Infrastructure Plan Technical Report VOLUME 1 Appendix B, E, L

3. Planning Methodology

Long Range Plan for Amtrak Cascades 2006, Chapter 5

Long Range Plan for Amtrak Cascades 2006, Appendix F

Amtrak Cascades Operating and Infrastructure Plan Technical Report VOLUME 1 Chapter 1 Chapter 2

Amtrak Cascades Operating and Infrastructure Plan Technical Report VOLUME 1 Appendix C, D, F, K

4. Demand and Revenue Forecasts

Amtrak Cascades Operating Costs Technical Report VOLUME 4

Amtrak Cascades Ridership and Revenue Forecasts Technical Report VOLUME 5

Amtrak Cascades Cross Modal Analysis Technical Report VOLUME 6

5. Operations Analysis

Amtrak Cascades Operating and Infrastructure Plan Technical Report VOLUME 1 Chapter 3

Amtrak Cascades Operating and Infrastructure Plan Technical Report VOLUME 1 Appendix G, H, I

6. Station and Access Analysis

Long Range Plan for Amtrak Cascades 2006, Appendix D

7. Conceptual Engineering and Capital Programming

Amtrak Cascades Operating and Infrastructure Plan Technical Report VOLUME 1 Chapter 4
Amtrak Cascades Operating and Infrastructure Plan Technical Report VOLUME 1 Appendix J
Amtrak Cascades Capital Cost Estimates 2006 Technical Report VOLUME 3

8. Operating and Maintenance Costs and Capital Replacement Forecast

Long Range Plan for Amtrak Cascades 2006, Appendix C
Amtrak Cascades Operating Costs Technical Report VOLUME 4

9. Public Benefits Analysis

Long Range Plan for Amtrak Cascades 2006, Chapter 6

» *Environmental Review*

The CID has an Environmental Review requirement.

▪ **NEPA document and SDP must be consistent, and share much of the same content**

- NEPA Purpose and Need ↔ SDP "Rationale, Goals, and Objectives"
- NEPA Alternatives Considered ↔ SDP "Identification of Alternatives"
- NEPA Alternatives Analysis ↔ SDP Service Planning

Long Range Plan for Amtrak Cascades 2006 p 2-3:

After extensive discussion with the Federal Railroad Administration (FRA), the Federal Highway Administration (FHWA) and the state Attorney General's staff, it was determined that the preparation of a corridor-wide environmental overview, in conjunction with a long-range plan, would fulfill the intent of the National Environmental Policy Act (NEPA). It was agreed by all parties that the plan would periodically be updated and would provide a foundation for future project-level environmental documentation.

Amtrak Cascades Environmental Overview Technical Report VOLUME 7

- **Along with Service NEPA, one of two components of a "Passenger Rail Corridor Investment Plan"**
Long Range Plan for Amtrak Cascades 2006, Chapter 7
- **Prior steps must be revisited as subsequent steps refine or revise assumption made in prior steps.**

Long Range Plan for Amtrak Cascades 2006, Chapter 8

Appendix B shows additional justification developed for correspondence with WSDOT.

FRA on the Use of Prior Work

Service Development Planning for Intercity Passenger Rail (FRA, 2015) states

"SDP structure may be linear, but the planning process is inherently iterative"

"Prior steps must be revisited as subsequent steps refine or revise assumption made in prior steps."

These statements strongly imply that consideration of prior work is required.

DRAFT STATEMENT OF WORK FRAMEWORK VERSION 2 - Corridor Identification and Development Program Step 2 Service Development Plan (FRA March 2024) states

"If applicable, a corridor sponsor may be able to use existing data, analyses, and approaches required to fulfill many of the subtasks associated with Task 2. In Step 1 of the CIDP, FRA will evaluate previous materials developed by the Recipient and determine whether previous methodologies and outputs fulfill the objectives of the subtasks; whether previous methodologies and outputs require an update or refresh; or whether the corridor sponsor needs to develop new components to fulfill the task. Based on the Step 1 intake process, the language under each sub-task is subject to modification."

Considering existing work in the SDP process is required in the 2015 document and is allowed in the 2024 document.

7. Amtrak Cascades, Covid-19, Remote Work, and Commuting

WSDOT has repeatedly stated that the effect of Covid-19 and remote work on Amtrak *Cascades* service must be studied before a decision on additional service can be made. Similar statements can be found from others, about the Amtrak *Cascades* and Sounder service. In some statements, the low ridership of Sounder 'post pandemic' appears to be a gauge with which the future of the Amtrak *Cascades* program is judged. Such statements imply that rail service is less useful because remote work has replaced the daily trip to the office.

Sounder service is not an appropriate model on which to base Amtrak *Cascades* assumptions. It is structured to accommodate the nine-to-fivers working in downtown Seattle. It also does not accommodate people whose trip passes through Seattle instead of beginning or ending there.

A cursory glance at I-5 near the Convention Center at the nine-to-fiver rush hour will show that the road is filled to capacity with cars that are on a trip passing through Seattle. A transit system that does not accommodate those other reasons to travel or all of the major travel patterns will have low ridership.

"Summary of Travel Trends, 2017 National Household Travel Survey" shows that commuting represents only 20 percent of travel by automobile:

Number (millions) of Person Trips by Mode of Transportation and Trip Purpose		
Purpose	Trips	Percent of Trips
To/From Work	56,981	19%
Work-Related Business	4,844	2%
Shopping and Errands	126,268	41%
School or Church	28,427	9%
Social and Recreational	78,890	26%
Other	10,988	4%
Total	306,398	

Amtrak *Cascades* is not a commuter service. The effect of and comparison to commuting is irrelevant. Ridership is currently high on moderate frequency, unreliable trains that cannot possibly be used for commuting. The full development of the Amtrak *Cascades* program is hourly service the length of the corridor. Table 3 shows the projected ridership of Timetable F Revision A from the LRP by train and time. The chart on the next page is a graph on this data. It clearly shows that the greatest expected travel is late morning and late evening.

After this ridership projection (2005 after the full service was planned), a question of reducing lower ridership trains arose. Regional travel doesn't generally work that way. People traveling on a train make a return trip on another train. If the return trip train is eliminated for low projected ridership, the person will not travel by train, reducing the number of riders on another train. That is the phenomenon that currently limits Amtrak *Cascades* and Sounder ridership. The repeated application of eliminating the lowest ridership trains can ultimately be used to prove that nobody rides trains.

2023 Revision A Estimate					
Train	Dir	Rank	Riders	End Markets	End Times
104	NB	8	174,436	PDX-VAC	0600-1122
101	SB	22	61,341	SEA-PDX	0606-0836
102	NB	11	104,552	SEA-VAC	0645-0922
106	NB	18	70,316	PDX-SEA	0700-0930
110	NB	10	130,259	EUG-SEA	0705-1130
103	SB	16	70,836	SEA-PDX	0707-0837
108	NB	7	191,601	PDX-VAC	0800-1322
105	SB	17	70,366	SEA-PDX	0806-1036
111	SB	1	293,915	VAC-EUG	0814-1530
107	SB	21	62,131	SEA-PDX	0906-1136
112	NB	25	57,312	PDX-SEA	1000-1230
116	NB	3	268,709	EUG-VAC	1005-1722
109	SB	24	58,362	SEA-PDX	1006-1236
114	NB	23	58,427	PDX-SEA	1100-1330
118	NB	2	284,536	EUG-VAC	1205-1922
113	SB	20	62,203	SEA-PDX	1206-1436
117	SB	6	197,422	VAC-SEA	1214-1736
115	SB	9	153,287	SEA-EUG	1406-1830
121	SB	5	200,082	VAC-SEA	1414-1936
120	NB	14	76,319	PDX-SEA	1500-1730
122	NB	13	84,717	PDX-SEA	1600-1830
119	SB	12	84,983	SEA-PDX	1606-1836
125	SB	4	234,115	VAC-EUG	1614-2330
124	NB	15	74,575	PDX-SEA	1700-1930
126	NB	26	45,565	PDX-SEA	1800-2030
123	SB	27	42,997	SEA-PDX	1806-2036
128	NB	30	34,665	PDX-SEA	1900-2130
130	NB	28	42,906	PDX-SEA	2000-2230
127	SB	29	42,228	SEA-PDX	2006-2236
129	SB	19	64,626	VAC-SEA	2014-2250

Table 3. Timetable F Revision A projected riders by train

Ridership Rank by Service Time

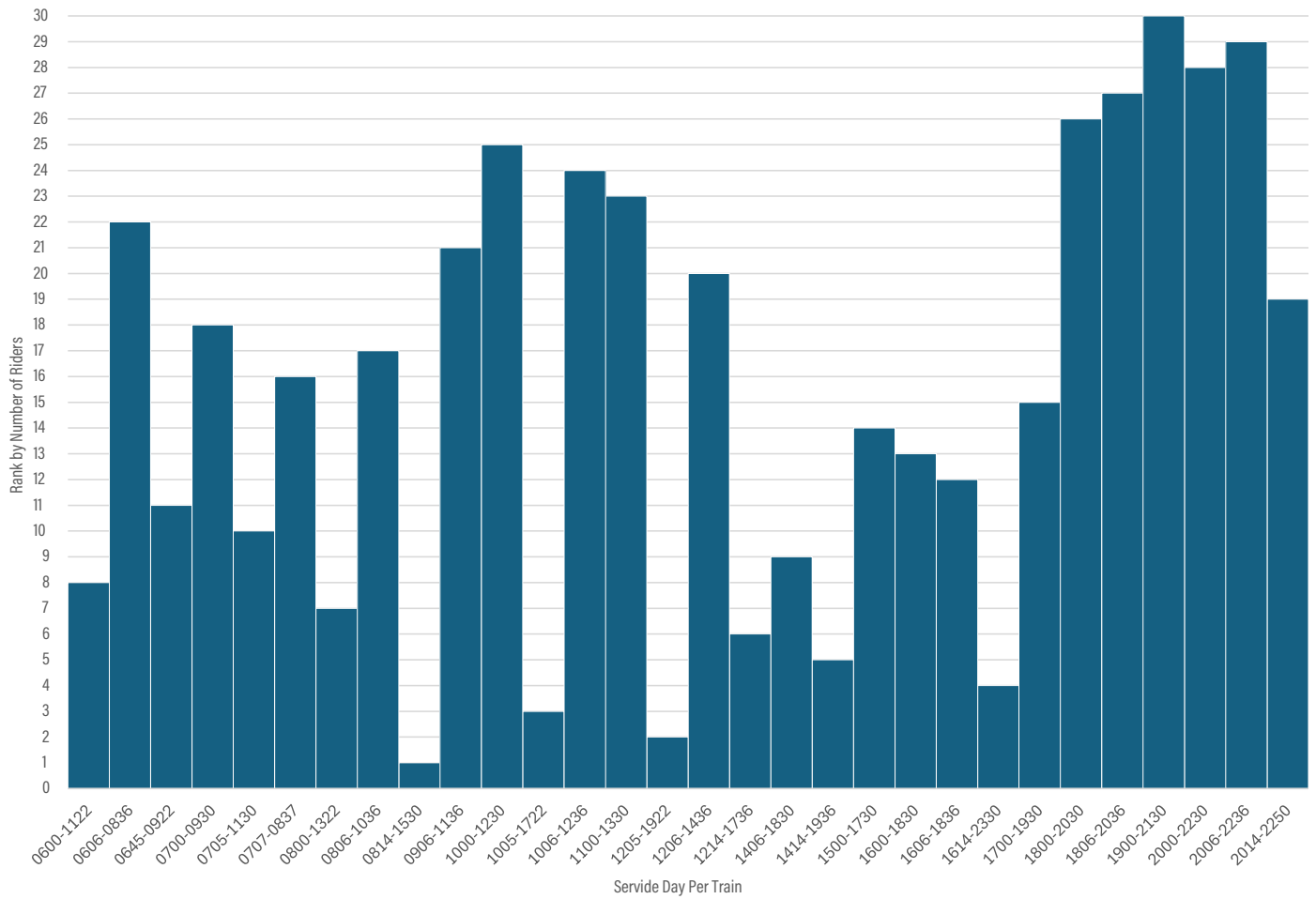

8. The WSDOT Service Development Plan Alternatives

The WSDOT Service Development Plan Alternatives

WSDOT is using the CID as a means to start the Amtrak *Cascades* program from the beginning, substantially extending the period of implementation and disposing of tens of millions of dollars of work.

The current work is a selection of an alternative from five candidates to develop. (Table 4)

Option	Seattle-Portland		Seattle-Vancouver		Seattle-Bellingham		Infrastructure Improvements Level		Maximum Speed
	Round Trips	Travel Time	Round Trips	Travel Time	Round Trips	Travel Time	North of Seattle	South of Seattle	
A	8	3h11m	2	3h46m	2	---	Low	Medium	79 mph
B	10	3h11m	3	3h46m	2	---	Low	Medium	79 mph
C	13	3h5m	3	3h39m	3	---	Low/ Medium	High	90 mph
D	13	Local (9) 3h11m Limited (2) 2h57m Express (2) 2h51m	3	Local (2) 3h11m Express (1) 2h51m	3	---	Low	Medium/ high	79 mph
E	16	3h5m	6	3h39m	0	---	Low/ Medium	High	90 mph

Table 4. Current SDP Alternatives

The purpose of the Amtrak *Cascades* program was mode shift from highway to rail. The program goals of Seattle-Portland 2 hours 30 minutes and Seattle-Vancouver BC in 2 hours 45 minutes were established as the minimum needed to be competitive with highway travel. None of the alternatives that WSDOT is considering for selection meet that requirement.

The stated level of infrastructure improvement appears to be unrealistic. The 2010 ARRA grant funded construction of a set of improvements from the LRP. All were abbreviated in some way.

The selected infrastructure improvements were intended to guarantee 88 percent on time performance for six Seattle-Portland round trips. Between 2018 and 2024, the Amtrak *Cascades* service has been no more than four round trips and was as few as one for a substantial period because of the Covid-19 pandemic. Yet, the best on time performance during that period was 66.3 percent between Seattle and Portland and 53.6% between Seattle and Vancouver BC. The lowest on time performance after the completion of the ARRA projects was 50 percent.

Given the goal of the 2010 ARRA grant and the failure to achieve the service goal, the stated level of infrastructure improvements for alternatives A-E does not appear to be sufficient.

Reducing travel time by skipping stations (Option D) is not an effective arrangement given the characteristics of the corridor. With the limited service of 2022 and poor punctuality, the ridership at the two lowest count stations between Seattle and Portland was 54 passengers per day at Kelso and 45 passengers per day at Centralia. The projection for the completed service in the LRP was 295 passengers per day at Kelso and 209 per day at Centralia. Neither appears to be a reasonable candidate for bypassing to reduce overall travel time unless express trains were a supplement to the full clock face service.

The 90 mph maximum speed of Options C and E is not as effective as it seems without context. There are 60 miles between Seattle and Portland that curvature and other conditions allow a 90 mph maximum speed. However, the potential 90 mph speed limit is separated into 18 different zones, the longest of which is 7.9 miles long. Segments of less than one mile were not counted. The shortest segment greater than one mile is 1.3 miles.

The chart below shows the Amtrak *Cascades* speed limits between Seattle and Portland, the degree of each curve along the route, and the segments over which an Amtrak *Cascades* train could travel at 90 mph. A train can take a substantial distance to accelerate to 90 mph, so although the potential speed limit is 90 mph, trains may not achieve that speed before needing to brake for the next speed restriction. Frequent braking and acceleration increase fuel consumption and maintenance cost.

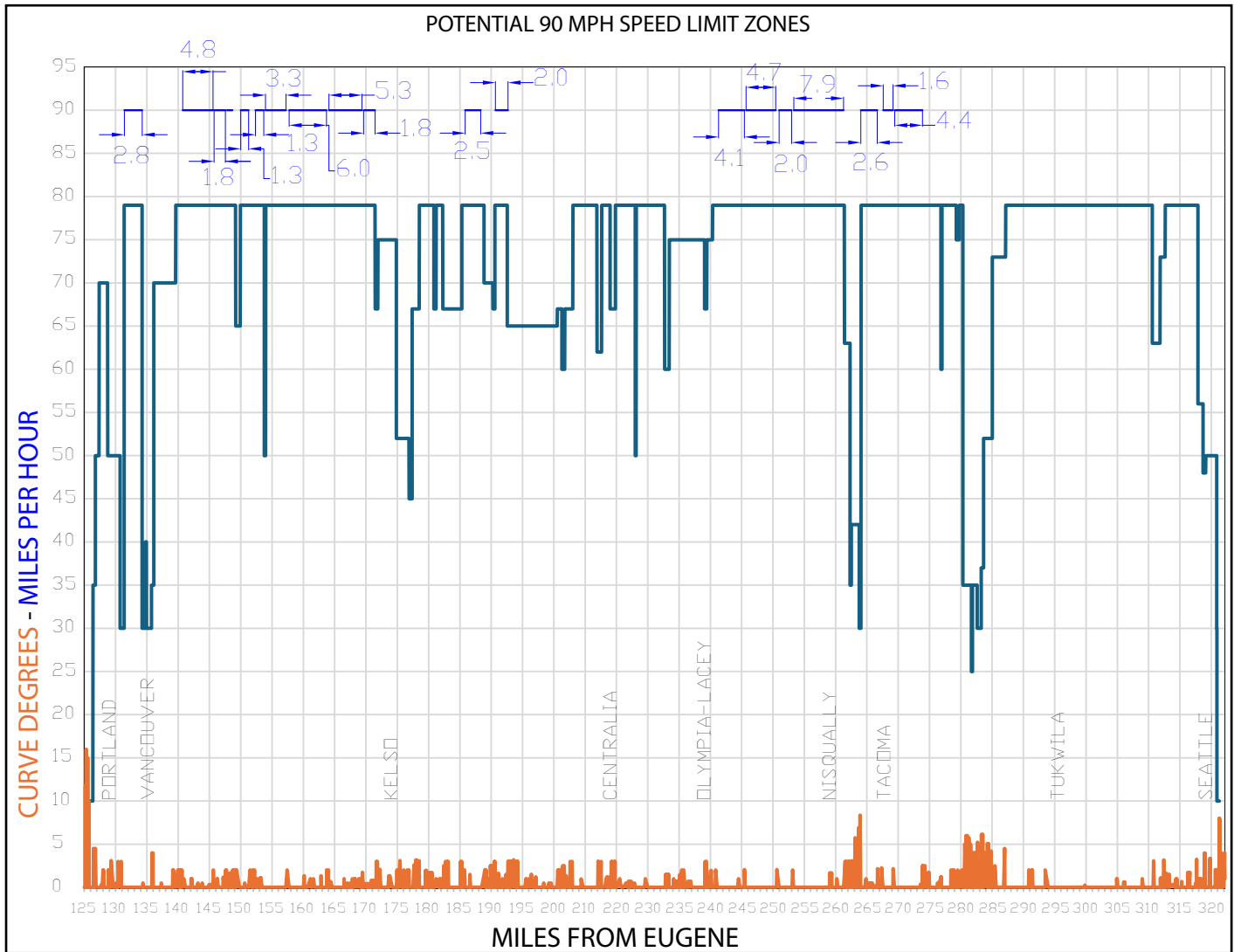

Proposed Service Alternative F

The Amtrak *Cascades* service must be structured to maximize mode shift from highway to rail. Mode shift is an essential climate emergency response. This is alternative F proposed by the Rail Can't Wait campaign that should be the minimum level of service for consideration. (Table 5)

Alternative F assumes infrastructure like that described in the LRP. That includes a passenger-dedicated 110 mph track between Felida (six miles north of Vancouver) and DuPont, between Marysville and Mt Vernon, between Burlington and Larabee State Park (three miles north of Samish), and between Bellingham and Surrey BC.

Option	Seattle-Portland		Seattle-Vancouver		Seattle-Bellingham		Infrastructure Improvements Level		Maximum Speed
	Round Trips	Travel Time	Round Trips	Travel Time	Round Trips	Travel Time	North of Seattle	South of Seattle	
F	16	2h30m	6	2h45m	0	---	High	High	110 mph

Table 5. SDP Alternative F

Between Portland and Vancouver, Lakewood and Marysville, and through Bellingham, the Amtrak *Cascades* trains would operate at normal conventional speed to avoid significant infrastructure investment to accommodate overtaking.

The LRP plan uses the clockface principle, uniform spacing of trains generates recurring infrastructure need. If the interval remains the same, additional trains can operate up to the full day of that interval. For example, infrastructure that can accommodate hourly trains can accommodate 24 trains.

20 Years is Too Long for Program Implementation

WSDOT states that implementing the new Amtrak *Cascades* SDP may take up to 20 years. It should take no more than about 12 years if the key projects were funded this year, with updated analysis and engineering started immediately. The LRP was to be fully implemented by 2018. Washington State can and must make this program a top priority.



9. Immediate Projects to Improve Passenger Service

The legislative instruction that established the Amtrak *Cascades* program called for a Seattle-Portland trip time of 2 hours 30 minutes to ensure travel time competitive with driving, the primary point of developing the program. The fastest current WSDOT Service Development (SDP) Plan alternative is 3 hours 5 minutes, not competitive with driving time, and offers no passenger-specific capital improvements between Seattle and Portland.

The Amtrak *Cascades* service must have a 2 hour 30 minute travel time between Seattle and Portland to be effective and successful. Shorter travel time has a positive effect on ridership. Since mode shift from highway to rail is an essential part of climate change response, WSDOT must pursue the original service goal of the LRP.

The LRP established projects, train schedules, and travel time. However, the 2010 ARRA grant projects did not complete all of the projects of Timetable B or C (the completion of each allowed a specific number of additional trains), but there are more Amtrak *Cascades* than provided for in Timetable B. The current situation differs from the situation when the projects were sequenced. Thus, a new assessment of projects and order must be made.

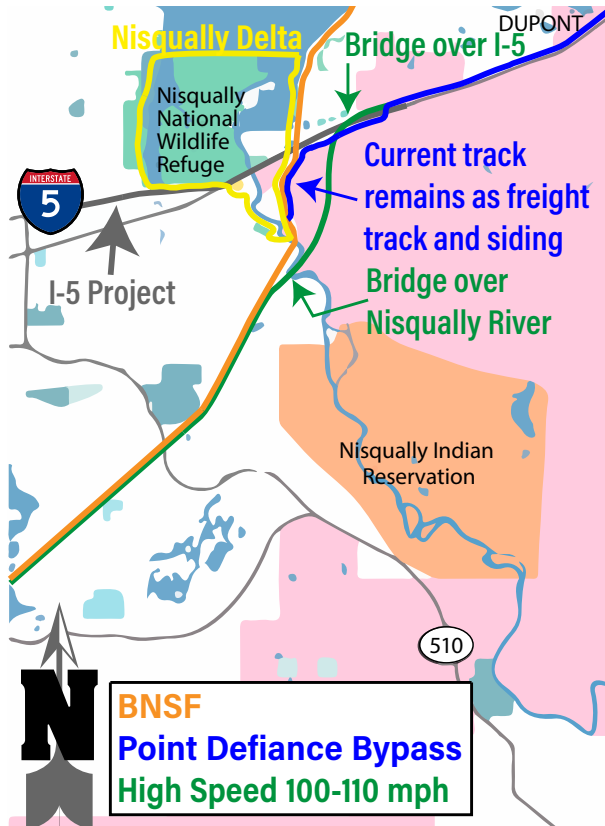

Point Defiance Bypass

The LRP calls for a dedicated passenger track, almost entirely 110 mph, between Felida and Nisqually, a Point Defiance Bypass line change to allow 100 mph, and two main tracks between TR Jct. and Lakewood to avoid conflict between Amtrak and Sounder trains. The ARRA grant project only constructed a second main track between S 66th Street (South Tacoma) and Rill (south of Lakewood). Sound Transit constructed a second track between L Street and D Street in Tacoma. The remaining single track segments north of S 66th Street are a source of delay for Amtrak and Sounder trains. Sound Transit has received a grant for construction of a second track between Pine Street and the South Tacoma station to improve, but not entirely fix, the situation.

The single track segment between Rill (south of Lakewood) and the beginning of the line change at Mounts Road was planned in the LRP as a matter of economy. In the full Timetable F service, no meets between Amtrak *Cascades* trains would occur in this segment. The timetables C, D, and E were arranged to also not require meets between Amtrak *Cascades* in this segment.

South of DuPont, the LRP provides for a 100 mph alignment change between Mounts Road and the south bank of the Nisqually River, connecting the 110 mph passenger track south of there. The existing line was constructed in 1914. From North to

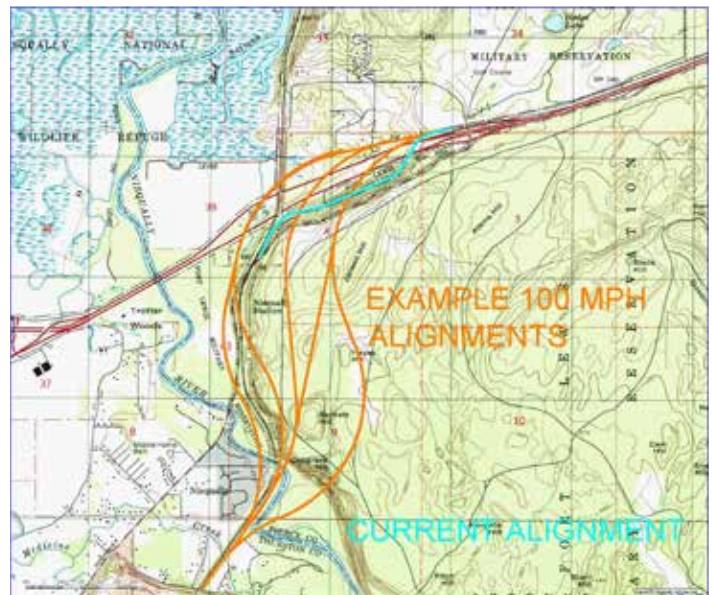
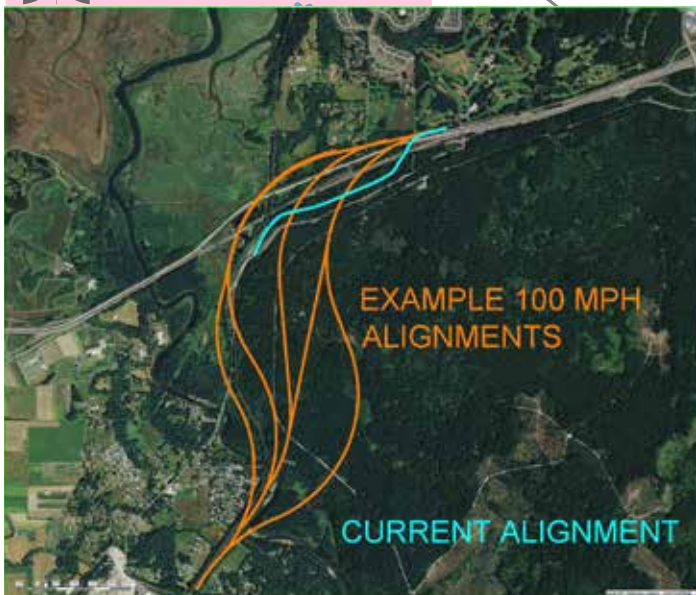

Examples of a 100 mph passenger train speed alignment between Mounts Road and the south bank of the Nisqually River.

south, there is 0.2 miles of 30 mph curve, 1.4 miles of 42 mph, a 35 mph switch connecting to the BN main tracks, and 1.1 miles of 63 mph over the Nisqually River bridge. This is the most restrictive segment of the Seattle-Portland line. Improving this section to 100 mph on a new alignment is essential to achieving a 2 hour 30 minutes Seattle - Portland travel time.

Upon completion of this project, the existing line remains in service as a siding and freight line. There is regular local freight service between Nisqually and Tacoma and occasional military trains between Nisqually and Mobase (Joint Base Lewis McChord) entering and leaving the PDB at Prairie Jct.).

The WSDOT SDP options do not include this project, thus do not sufficiently reduce travel time. The WSDOT options include a siding at DuPont. A siding at this location will serve to increase passenger train delays. BNSF does not want a passenger train to meet an opposing passenger train at Nisqually, effectively blocking both main tracks. If a situation of passenger trains at Nisqually arises, BNSF will hold the southbound train on the siding at DuPont regardless of the schedule of either train.

110 mph Passenger Track between Nisqually and Centralia (Wabash - Big Hanaford Road)

This project has been called 110 mph Passenger Track between Nisqually and Wabash (Big Hanaford Road) but the scope is greater than the title. The title is limited to denote the most significant part of the work.

This segment is in the last two phases (Timetables E and F) of the LRP. At that point, the track would serve predominantly as one of the last two travel time reduction projects, also providing the ability to add additional two Seattle-Portland round trips. However, the projects selected for the ARRA grant and the number of trains added

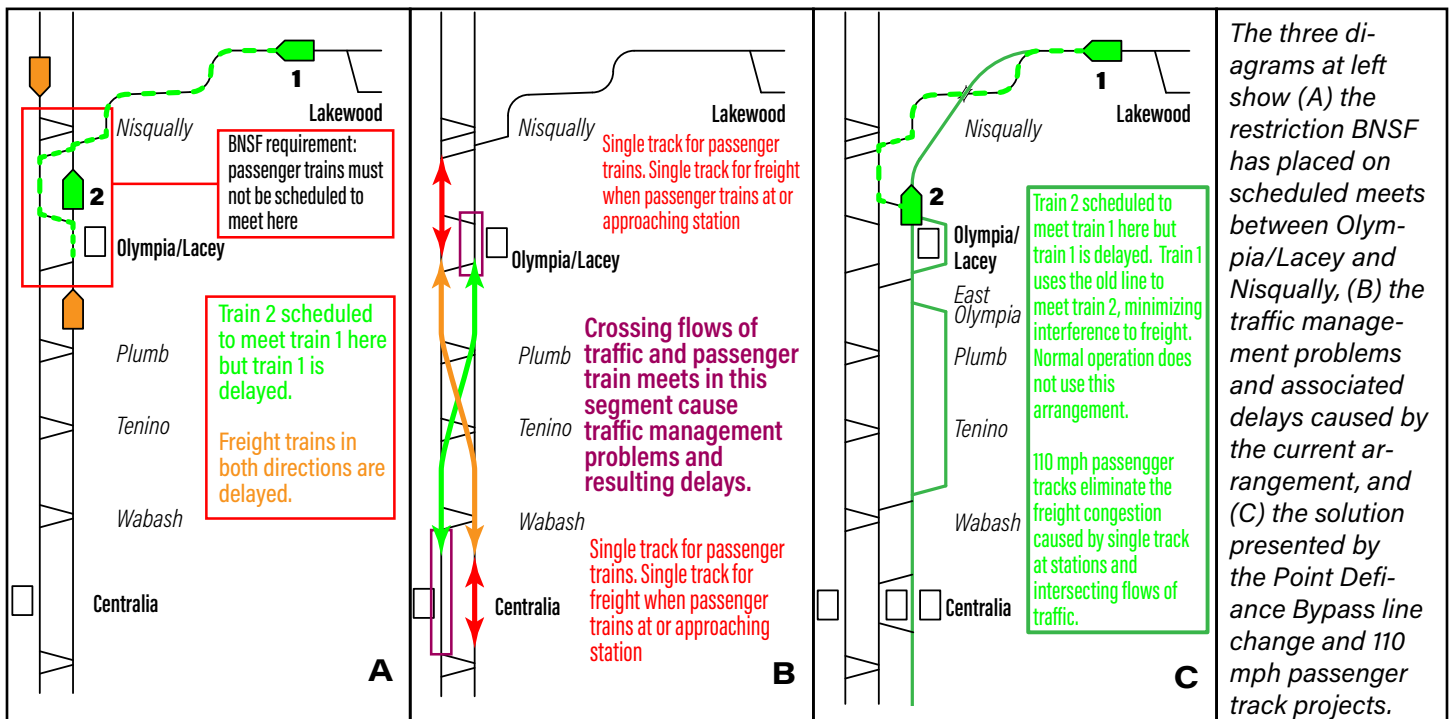
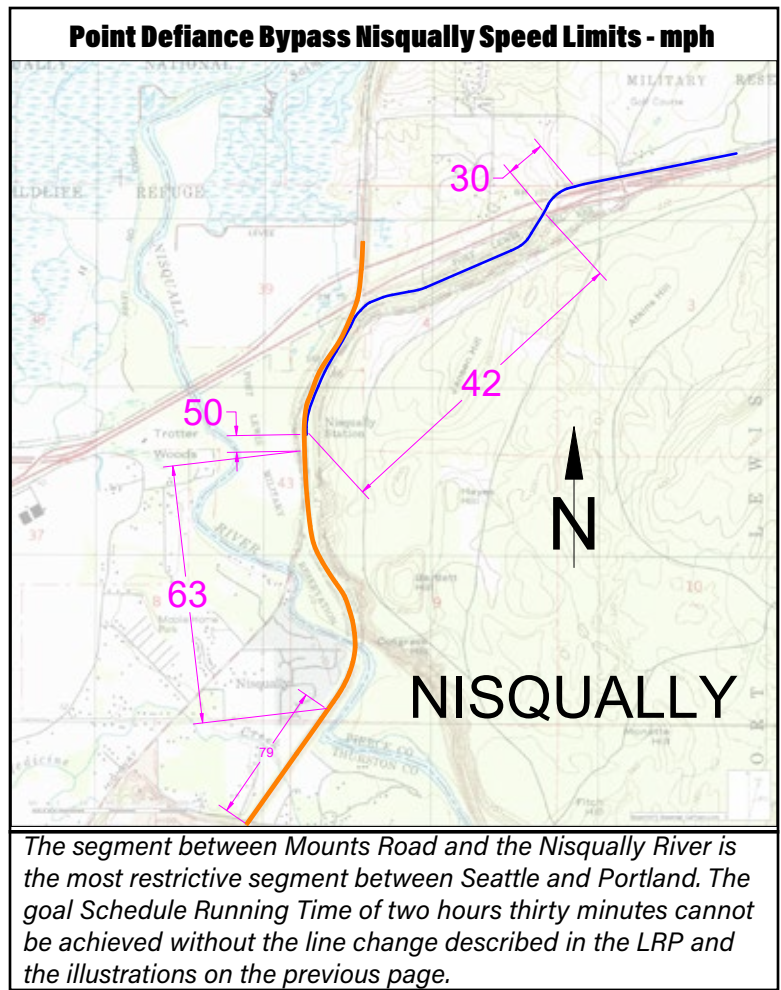

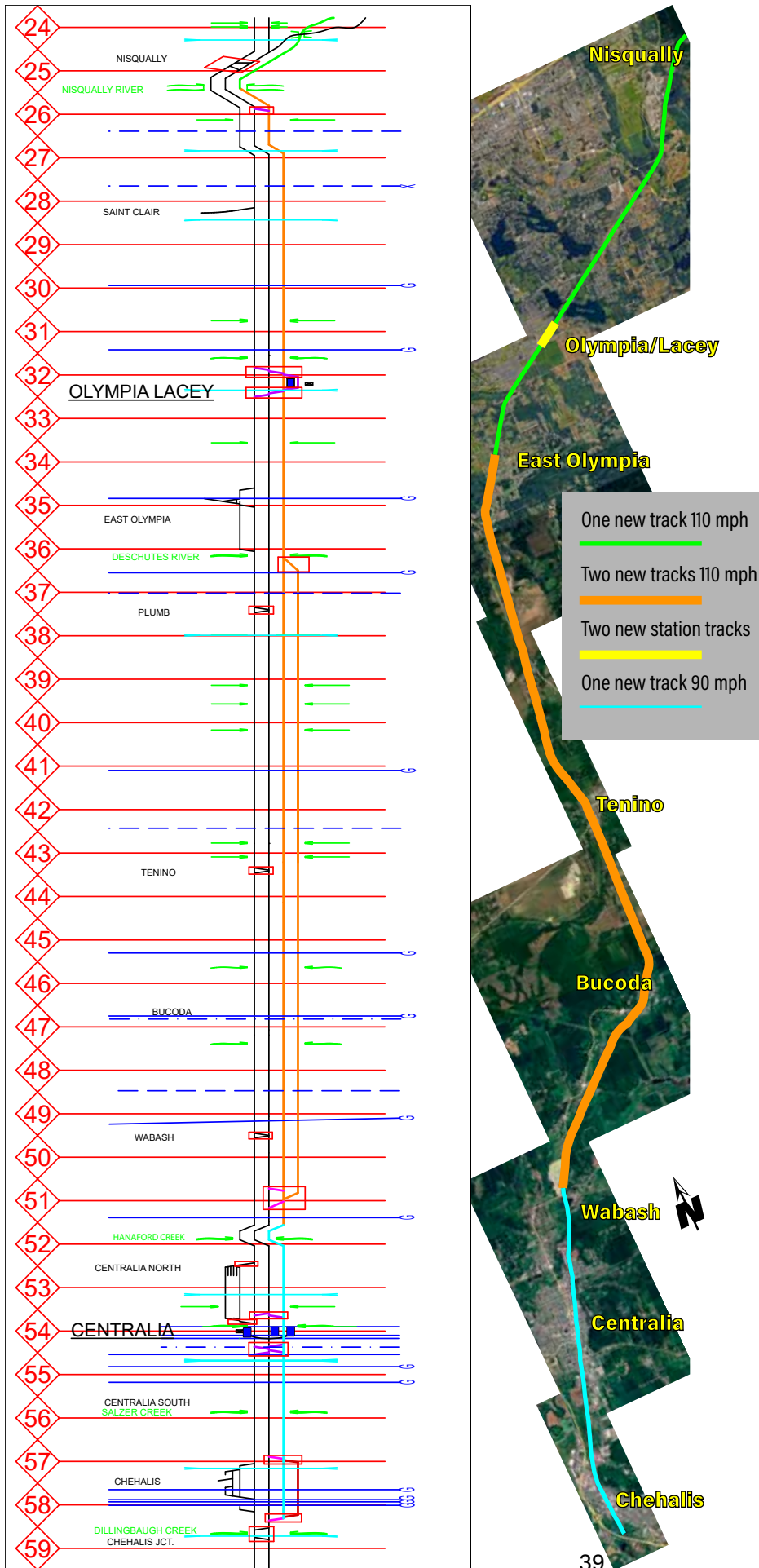

to the existing timetable has created a congestion and timetabling problem between Centralia and Lakewood.

The need for passenger trains to use the west track at Centralia, the East track at Centennial, the BNSF requirement to not meeting opposing passenger trains between Centennial and Nisqually, the number of potential conflicts with Sounder schedules, and the need for the opposing Seattle-Vancouver BC trains to meet in the passenger siding at Stanwood has created a tenuous situation that is aggravated by delayed trains. A good timetable allows conflict resolution with a small buffer time to accommodate a slightly delayed train. The current arrangement has none for many of the conflicts and some require slowing one of the trains involved in a conflict by up to five minutes.

The 110 mph passenger project in the LRP includes a second 110 mph passenger track between East Olympia and Centennial. It also includes a second passenger track at the Centennial station, which would be included in the Nisqually-Wabash 110 mph track.

Current Amtrak *Cascades* travel time between Tacoma and Centralia is 52 minutes. The combined Point Defiance Bypass and Nisqually-Wabash passenger main project will reduce the time to 38 minutes and reduce the Seattle-Portland travel time from 3 hours 25 minutes to 3 hours 11 minutes.

The LRP includes an 80-90 mph passenger track (another part of the Felida-Nisqually passenger tracks) between Wabash and Chehalis. This segment improves reliability significantly and reduces Seattle - Portland travel time by an additional two minutes.

The project includes relocating the main passenger platform to the east side of the line, accommodating the passenger track when it is constructed. This would eliminate the freight-passenger conflict at the Centralia Station, reducing freight and passenger delays and improving the reliability of the Amtrak *Cascades* service.

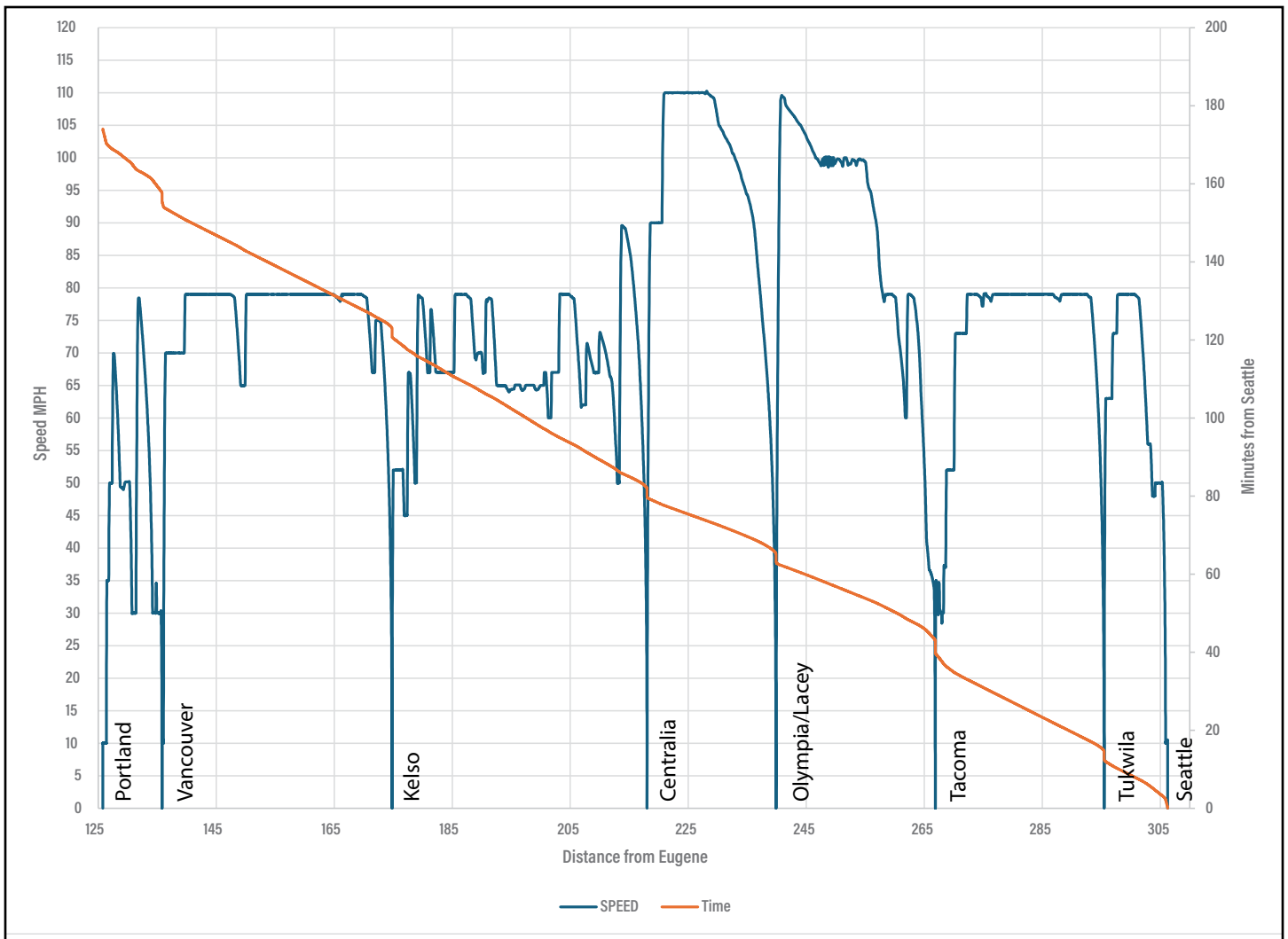

This diagram shows the speed and travel time of an Amtrak Cascades train between Seattle and Portland after the proposed projects are complete.

Current	New	Station
5:52 am	5:52 am	Seattle
6:07 am	6:06 am	Tukwila
6:40 am	6:34 am	Tacoma
7:13 am	6:57 am	Olympia/Lacey
7:33 am	7:13 am	Centralia
8:12 am	7:54 am	Kelso
8:51 am	8:29 am	Vancouver
9:17 am	9:01 am	Portland

Table 6. Example of current schedule and schedule after proposed projects.

Travel Time Difference

The current Seattle-Portland travel time is 3 hours 25 minutes. The proposed projects would reduce the travel time to 3 hours 9 minutes.

Project Cost

Based on the detailed estimate that was included in the LRP, adjusted 48 percent for inflation, to the extent possible for conditions that have changed, with 46 percent contingency (30 percent in

the original estimates and an added 16 percent), the total cost of the combined projects between Mounts Road and Chehalis would be \$1.5 billion for 36 miles, \$41.7 million per mile. Appendix C (page 59) contains the detailed project cost sheets from the LRP.

The cost compares favorably with the cost of several highway projects on the WSDOT website as shown in the table.

Note that the I-90 Snoqualmie Pass improvement project was

Project	Cost
PDB Line Change	263,982,002
Nisqually-Wabash	513,000,000
Wabash-Chehalis	81,786,309
Centralia Station	15,000,000
Subtotal	876,768,311
Inflation 48%	419,408,789
Total	1,293,177,100
Additional Contingency 16%	206,908,336
Total	1,500,085,436

Table 7. Estimated project cost based on estimates developed for LRP, adjusted for inflation.

Highway Project	Cost (million)	Miles	Cost Per Mile (million)
I-5 Mounts Road - Thorne Lane	495	6.8	72.8
Hyak-Keechelus	551	15	36.7
Keechelus-Stampede	108	2	54.0
Stampede-Easton	426	8	53.3
Spokane Corridor	1,500	10.5	142.9
I-5 Nisqually Delta	2,000	2.3	880.0

Table 8. Example highway construction cost.

funded in 2005, a year before the last update of the LRP, has been under construction since 2009, is not complete, and is still being funded. However, WS-DOT considers the LRP to be obsolete because of its age.

The delay thus far to these projects has cost over 400 million dollars.



10. Funding for Immediate Improvement

Chapter 6 (“6. Long Range Plan as a Service Development Plan” on page 29), describes the CID program that FRA is using as the basis for allocating grants for improvement of passenger rail corridors. Further development of the Amtrak Cascades service must produce or update an SDP. Even proceeding with the LRP will require time to review and update the substantial body of work.

However, there is another federal grant program that can be applied to the immediately needed projects in Chapter 9 (page 37). That is the Consolidated Rail Infrastructure and Safety Improvements Program (CRISI).

Previous Grant Programs

The CRISI grant program is the most recent in the series of federal grant programs that have been available to the PNWRC for similar purposes. The first was the Intermodal Surface Transportation Efficiency Act of 1991 (ISTEA). It was followed by the American Recovery and Reinvestment Act of 2009 (ARRA) which provided for Transportation Investment Generating Economic Recovery (TIGER) grants.

CRISI Grants

Overview: This program funds projects that improve the safety, efficiency, and reliability of intercity passenger and freight rail.

(In the following list, the criteria that apply to the Point Defiance Bypass and Centralia-Nisqually project are in **bold** typeface):

Eligible Projects: Projects eligible for funding under this grant program include, but are not limited to

- *Deployment of railroad safety technology;*
- **Capital projects, as defined in section 49 U.S.C. § 24401(2) (renumbered to 22901) for intercity passenger rail service, except that a project under this NOFO is not required to be in a state rail plan;**

The section applicable to this project is

. . . acquiring, constructing, improving, or inspecting equipment, track and track structures, or a facility for use in or for the primary benefit of intercity passenger rail service, expenses incidental to the acquisition or construction (including designing, engineering, location surveying, mapping, environmental studies, and acquiring rights-of-way), payments for the capital portions of rail trackage rights agreements, highway-rail grade crossing improvements related to intercity passenger rail service, mitigating environmental impacts, communication and signalization improvements, relocation assistance, acquiring replacement housing sites, and acquiring, constructing, relocating, and rehabilitating replacement housing;

- *Capital projects that:*
 - **address congestion challenges affecting rail service,**
 - **reduce congestion and facilitate ridership growth along heavily traveled rail corridors, and/or**
 - *improve short-line or regional railroad infrastructure;*
- **Highway-rail grade crossing improvement projects;**
- **Rail line relocation and improvement projects;**
- *Regional rail and corridor service development plans and environmental analyses;*
- *Any project necessary to enhance multimodal connections or facilitate service integration between rail service and other modes;*
- *The development and implementation of a safety program or institute;*
- *Any research that the Secretary considers necessary to advance any particular aspect of rail related capital, operations, or safety improvements; and*
- *Workforce development and training activities, coordinated to the extent practicable with the existing local training programs supported by the Department of Transportation, the Department of Labor, and the Department of Education.*

Climate Commitment Act (CCA)

The Climate Commitment Act (CCA), RCW 70a.65 includes a cap and invest program. Within that program, the Carbon Emissions Reduction Account (CERA) funds are available for carbon emissions reduction in transportation.

There are three eligible categories:

- Reducing transportation emissions,
- Investing in alternatives to single-occupancy vehicles,
- Investing in emissions reduction programs for freight, ferries, and ports.

The PNWRC program, the Amtrak *Cascades* service, qualifies under all three categories.

Since rail transportation produces about one-third the emissions of highway for equivalent transportation, mode shift from highway to rail reduces emissions. Passenger rail service that is convenient, comfortable, dependable, and competitive with driving reduces highway travel, including single occupancy vehicles. The better the route is configured for dependable passenger service, the less that freight trains wait for passenger trains. Keeping freight trains moving instead of idling while waiting for passenger trains will reduce freight train emissions.

An important question in determining the projects to fund is the amount of time needed to effect results. For example, the Amtrak *Cascades* service improvements generally involve incremental improvement to an existing railroad, involving only small parcels of land acquisition.

Railroad improvement can be very effective in a relatively short period of time. In five years, the projects funded by the 2010 ARRA built 15 miles of new main track, rebuilt 10 miles of existing track, extensively reconfigured yards at Vancouver, Kalama, and Longview Jct., and did extensive track and signal work reconfiguring North Portland Jct. and the south end of King Street Station, extended Mt. Vernon siding, constructed a new two track customs facility at Swift (between Blaine and Custer), and made many signal improvements including PTC, and replaced many switches with lower maintenance types.

However, three other examples illustrate what can be done.

The Thistle Utah landslide of 1983 destroyed the town of Thistle and the railroad and highway through it. The Denver & Rio Grande Western railroad was forced to relocate, building six miles of mountain terrain railroad, including stabilizing the landslide area and a 3,000 foot tunnel, in three months. The adjacent highway repair and relocation took 18 months.

In 1979, BN completed about 100 miles of new railroad across the plains of Wyoming. Construction took three years.

In 1967, Southern Pacific Railroad completed a new 78 mile long railroad across a mountain range and a desert between Colton and Palmdale, California. Construction took two years.

Of course, current environmental regulations lengthen the process. These examples were in unpopulated areas, so land acquisition was not difficult. However, they are similar in nature to constructing PNWRC improvements generally on or adjacent to existing railroad right of way.

Federal-State Partnership for Intercity Passenger Rail Grant Program

From the FRA website:

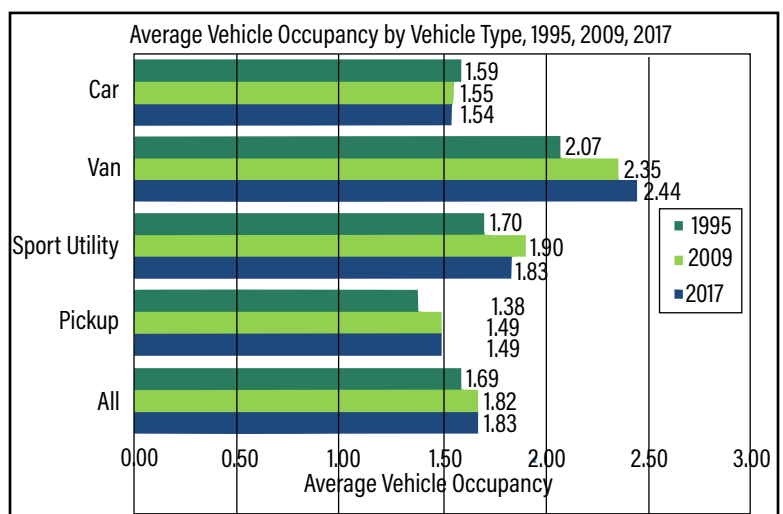

Bureau of Transportation Statistics data (Washington State data is not available) shows that average vehicle occupancy in 2017 (the latest data) is 1.83 persons. To simplify the example, round that up to the average highway vehicle is occupied by two passengers. Two seats on a train is the equivalent of a highway vehicle (car, SUV, van, pickup).

The emissions produced by a train are a third of those produced by a highway vehicle. Two seats on a train offset the emissions of six highway vehicles.

This program provides funding for capital projects that reduce the state of good repair backlog, improve performance, or expand or establish new intercity passenger rail service, including privately operated intercity passenger rail service, if an eligible applicant is involved.

Eligible Projects:

- *A project to replace, rehabilitate, or repair infrastructure, equipment, or a facility used for providing intercity passenger rail service to bring such assets into a state of good repair*
- *A project to improve intercity passenger rail service performance, including reduced trip times, increased train frequencies, higher operating speeds, improved reliability, expanded capacity, reduced congestion, electrification, and other improvements, as determined by the Secretary*
- *A project to expand or establish new intercity passenger rail service*
- *A group of related projects as described above*
- *The planning, environmental review, and final design of an eligible project or group of projects described above*



11. Further Passenger Service Improvement Projects

The methodology the LRP remains valid. Further steps can use that as a framework. Freight problems that existed before the program started have been fixed. If there are remaining freight congestion problems, they are a result of changes in BNSF operating practices or traffic level since the substantial upgrade for freight traffic congestion elimination was completed.

If speeds and timetables remain the same, the second passenger track segments for meets should remain as they were designed. A substantial change in traffic such as Amtrak *Cascades* express trains or trains that are not on hourly headway could require a second passenger track throughout. Such changes might include local passenger service between Olympia, Lacey, and Tacoma, occasional express Amtrak *Cascades* service, high speed truck shuttle trains such as operate in Europe, and perhaps additional local service serving the smaller communities such as Tenino, Chehalis, Winlock, Castle Rock, Kalama, Woodland, and Ridgefield.

The goal number of trains and the goal travel times are all within possibility. The original program was designed for implementation over 20 years; however, 20 years is not necessary to complete the implementation of the LRP. A substantial part of Timetables A, B, and C have been completed. The construction time of the remainder could be shortened if desired by constructing a greater number of the projects simultaneously.

An immediate step would be a new analysis for order of projects. The projects constructed thus far have been abbreviated from their LRP equivalents and projects have not been constructed in the order the LRP anticipated necessary for the planned service increases and improvements.



12. Build New or Improve The Existing?

The 1983 and 1992 High Speed Ground Transportation reports cited the high cost and long construction time of dedicated right of way Ultra High Speed Rail (UHSR) as the reason that Amtrak service must be improved to the extent possible as soon as possible.

Build New

WSDOT is engaged in developing UHSR between Vancouver BC and Portland. The program published a feasibility study in 2017, a business case study in 2019, and a Governance, Engagement, and Finance Strategy in 2020. The program has not completed conceptual or preliminary engineering. Route and stations have not been identified. Costs that were published in the 2017 report are derived from the cost of other projects.

The Washington State Joint Transportation Committee commissioned the *CASCADIA UHSGT REVIEW* (June 2023) (The Review). The Review stated that the cost of the currently in progress UHSR program would be an estimated \$36 - 63 billion instead of the \$24 - 42 billion estimated by the program. It appears, however, that the cost may exceed, perhaps substantially, the revised figure.

The 1992 report estimated 33-70 miles of tunnel needed for High Speed Rail. Urban development, a significant reason for tunneling, has increased substantially in the past 30 years. The Review estimated 80-90 miles of tunnel for the current UHSR proposal. The Review stated that a construction cost for the tunnels could be expected to be about \$450 million per mile. However, examination of other extensive tunneling projects demonstrates a cost substantially higher:

- New York 2nd Ave Subway: 1.8 miles \$4.45 billion (\$2.47 billion per mile) (10 years construction time — 0.18 miles per year)
- New York East Side Access: 2 miles but 6 tracks therefore, 0.7 miles of two track tunnel \$11.1 billion (\$15.9 billion per mile) (16 years construction time — 0.04 miles per year)
- Seattle SR99 tunnel: 1.8 miles \$2.15 billion (\$1.19 billion per mile) (four years construction time — 0.45 miles per year)
- Gotthard Base Tunnel: 35.5 miles \$13 billion (\$366 million per mile) (seven years construction time — 5.07 miles per year)
- Lötschberg Base Tunnel 21.5 miles \$4.6 billion (\$214 million per mile) (eight years construction time — 2.69 miles per year)

The first three are urban tunnels in the US. The bulk of UHSR tunneling would be below urban areas, encountering a substantial amount of underground infrastructure. The last two examples are in uninhabited areas of Switzerland. US constructions costs are typically the highest in the world, so even whatever tunneling might be necessary in uninhabited areas would probably cost more than the Swiss examples.

Construction time for 90 miles of tunnel would be substantial, even broken into several simultaneous projects. The construction rate of each of the three urban tunneling examples above is less than a half mile per year. Each of the US examples took two or more years between funding and construction. For example, broken into three simultaneous projects, one each for the Vancouver, Seattle, and Portland metropolitan areas, tunnel construction could be expected to take decades. The best case example is the Gotthard Base Tunnel, relatively simple construction and about the length of one of the example UHSR tunneling projects, took eight years. However, at the rate of construction of the US examples, each of the three projects of about 30 miles would take 60 to over 100 years of construction.

Property acquisition will have a substantial effect. The route and stops being unknown, it is impossible to assess potential property cost for the program. Assuming a reasonably direct route, the Vancouver BC - Portland route would be 300 miles. Given 90 miles of tunnel and 100 foot right of way, the route would need to acquire 2,545 acres.

Improve Existing

The LRP is a conceptual engineering document for the PNWRC program. The level of detail is represented in the cost sheets in Appendix C (page 59).

The program represented in the LRP involves:

- Excavation • 7,820,000 Cubic Yards
- Track Construction • 1,114,000 Linear Feet
- Railroad Bridges • 62,237 Linear Feet
- Culverts • 11,370 Linear Feet
- Retaining Walls • 137,400 Square Feet

- Highway Bridges ▪ 183,400 Square Feet
- Road Construction ▪ 303,350 Square Yards
- Embankment ▪ 419,100 Cubic Yards
- Property Acquisition ▪ 333 Acres

The estimated cost to complete the program based on the LRP and adjusted 48 percent for inflation and additional contingencies (30 percent contingencies are included in the original cost figures) is \$6 billion.

The two immediate projects, Point Defiance Bypass alignment change and the Nisqually-Centralia passenger track require only about 59 acres of right of way acquisition, 28 developed, 31 undeveloped.

Big Benefits - Short Time

Improving the existing infrastructure and substantially improving service is cost effective and timely. The effective Amtrak Cascades service of the LRP can be fully functional for about a tenth of the cost of UHSR and can be completed decades sooner.

The LRP was shelved 17 years ago. The original intent was to review and update at intervals of five years or less. Details of the work must be brought up to date. However, the LRP demonstrates that the effective passenger service it represents is feasible.

The data also demonstrates that the full service, as described in the LRP, can operate at between a small subsidy and a substantial positive revenue. Given the changes of the past 17 years: population growth, climate change awareness and the need to act with urgency, and the mobility needs of those who do not drive and/or do not live in the largest urban centers, fully updating the LRP will almost surely demonstrate a greater need for the service described in the LRP and likely demonstrating the need for more service than is planned in the LRP. The additional service may be added by filling the empty mid-day schedule in Timetable F or by extending the service day, still maintaining the hourly headways the infrastructure was designed to accommodate.

Appendix A Kalama - Kelso Before and After Passenger Projects

BURLINGTON NORTHERN BEFORE AMTRAK CASCADES PROJECTS

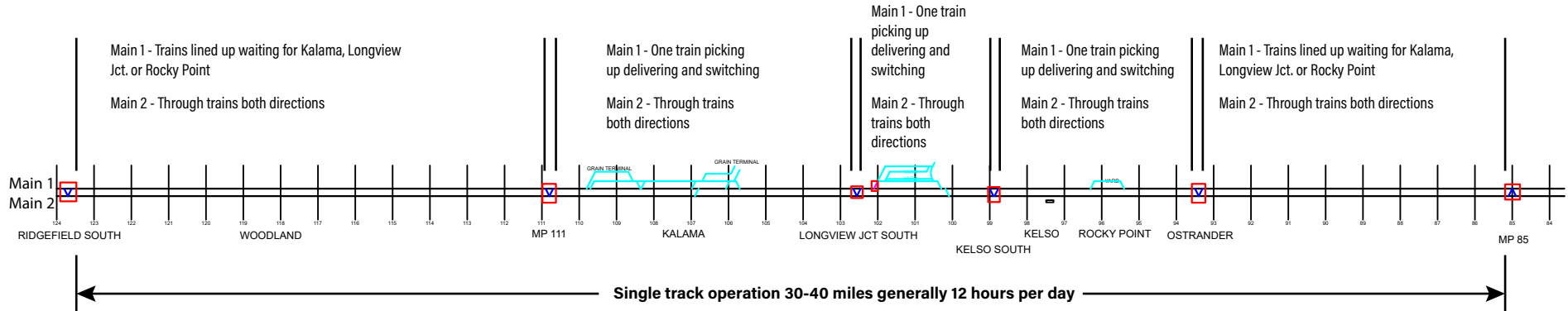

- Control Point - dispatcher controls signals and switches
- Track with switches manually controlled by train crew
- Freight siding controlled by dispatcher
- Main Track controlled by dispatcher

BNSF AFTER AMTRAK CASCADES PROJECTS

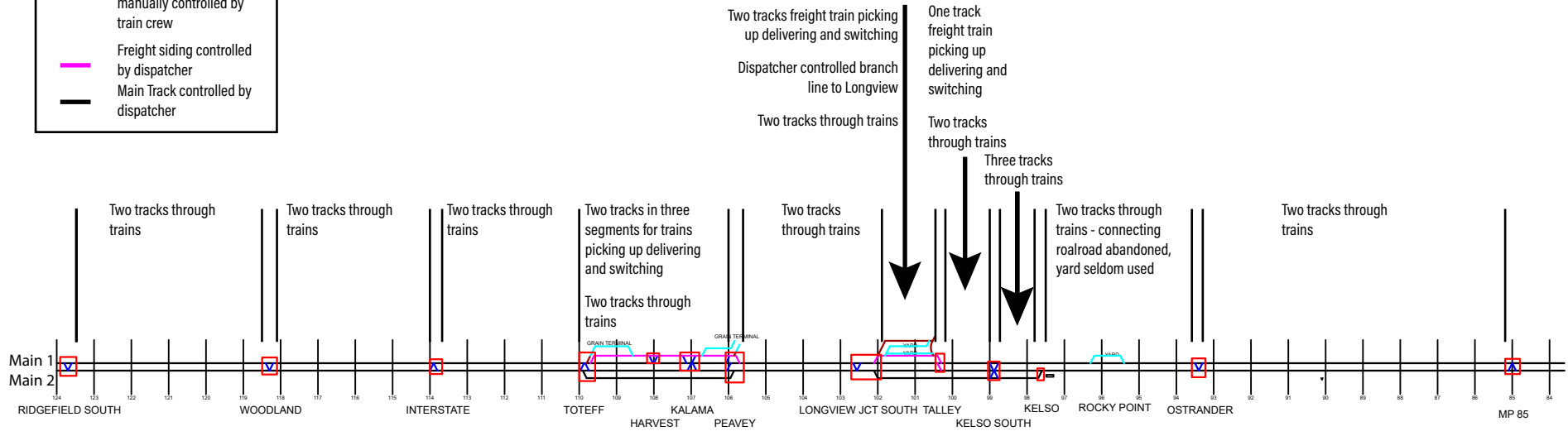

Six trains picking up, delivering, and switching without single track operation



Appendix B - Additional Description of the LRP as an SDP

Solutionary Rail requested that WSDOT provide a detailed listing of reasons that they do not consider the LRP to be an SDP. WSDOT compiled a list of FRA requirements for a Service Development Plan (left column), WSDOT's reason that the LRP does not comply (middle column). Responses from the Rail Can't Wait Campaign to these comments are in the right column.

SDP description in Bipartisan Infrastructure Law (enacted 11-2021)	WSDOT Reason that Long Range Plan does not comply	2006 Long Range Plan
(1) a detailed description of the proposed intercity passenger rail service, including train frequencies, peak and average operating speeds, and trip times;	Average speed not identified.	<p>Includes frequencies, trip times, peak speed.</p> <p>Average speeds were calculated given the extensive data for each iteration of the build out of the Amtrak Cascades improvements outlined in the Long Range Plan (LRP). The final, end of project speeds, trip times and thus average speeds were derived by dividing Distance by Trip Time, as follows:</p> <p>Timetable F, Revision A:</p> <ul style="list-style-type: none"> ▪ Distance between Seattle and Portland is 176 miles/2.5 hrs = 74.4 mph average speed. ▪ Distance between Seattle and Vancouver, BC is 150 miles/2.7 hrs = 55.5 mph average speed. ▪ Distance between Portland and Vancouver is 326 miles/5.2 hrs = 62.7 mph average speed.

<p>(2) a corridor project inventory that—</p> <p>(A) identifies the capital projects necessary to achieve the proposed intercity passenger rail service, including—</p> <ul style="list-style-type: none"> (i) the capital projects for which Federal investment will be sought; (ii) the likely project applicants; and (iii) the proposed Federal funding levels; <p>(B) specifies the order in which Federal funding will be sought for the capital projects identified under subparagraph (A), after considering the appropriate sequence and phasing of projects based on the anticipated availability of funds; and</p> <p>(C) is developed in consultation with the entities listed in subsection (e);</p>	<p>(A) Does not identify which capital projects will seek Federal funding, who will apply for the Federal funding, and how much will be requested.</p> <hr/> <p>(B) Does not specify the order in which Federal funding will be sought.</p> <hr/> <p>(C) Consultation with entities (who, what, and when) during development of the plan unclear.</p>	<p>Lists project inventory:</p> <p>(A) All projects in the LRP were and are subject to Federal funding. WSDOT applies for federal funding and determines how much is needed per project. The LRP lists estimates for capital costs that need to be updated as part of a regular update process.</p> <hr/> <p>Provides phasing of projects (order of implementation and grouping by “building block”):</p> <p>(B) There are six phases of construction - A through F, which clearly indicates an order for projects and funding.</p> <hr/> <p>(C) There was sufficient consultation to get the LRP accepted as a Programmatic EIS. Consultation for individual projects had started; HDR Engineering held the main contract. With a change of department management, work stopped and was discarded. What is needed is a new contract with a consultant for a scope of work commensurate with conducting an update of the LRP, with an expectation to complete work by December 31, 2023. An existing service on an existing line should require only a low or middle level of effort for completion/updating of an SDP. The current contract and scope of work do not match program update requirements.</p>
<p>(3) a schedule and any associated phasing of projects and related service initiation or changes;</p>	<p>Schedule not identified (subject to funding availability).</p>	<p>Phasing and relation to service changes identified.</p> <p>The LRP had a schedule with dates identified until the new management of the department quit working with the legislature and dismissed the existing work as “impractical”.</p>
<p>(4) project sponsors and other entities expected to participate in carrying out the plan;</p>		<p>Sponsor and other entities are identified.</p>
<p>(5) a description of how the corridor would comply with Federal rail safety and security laws, orders, and regulations;</p>	<p>Not addressed</p>	<p>The assumption was and can be made that the Cascades operates on an FRA regulated railroad. FRA is the safety regulator. Nothing happens without FRA approval. All construction and operations were then and are now conducted as prescribed in 49 CFR 200-299. Amtrak’s System Safety Plan was then and is now applicable.</p>

(6) the locations of existing and proposed stations;		Station locations identified.
(7) the needs for rolling stock and other equipment;		Equipment needs are identified.
(8) a financial plan identifying projected— (A) annual revenues; (B) annual ridership; (C) capital investments before service could be initiated; “(D) capital investments required to maintain service; “(E) annual operating and costs; and “(F) sources of capital investment and operating financial support;	Forecasts outdated Cost estimates outdated Sources of operating financial support not assigned to service partners.	Annual revenue, ridership, and operating costs forecast out to 2023. WSDOT discarded the work in 2006. Forecasts must be updated now to reflect current conditions as part of a regular process of updates to the program. <hr/> Capital investment cost estimated in 2006 dollars. As with operating costs, costs for capital projects must also be updated as part of a regular process of updates to the program, <hr/> Sources of potential financial support generally identified by geography. Sources of potential financial support were identified in the main volume of the LRP, Chapter 7, Financial and Institutional Framework, and must be updated as part of a routine update process.
(9) a description of how the corridor would contribute to the development of a multi State regional network of intercity passenger rail;	Not addressed.	One end of the Cascades line is in British Columbia. The other end is in Oregon. The Cascades route also ties into the Empire Builder northern and southern routes, and it also ties into the Coast Starlight to California. RCW 47.79.020 which mandated the development of the LRP also requested the development of East/West service through Washington which has not yet been adequately studied, or funded. Despite that, the above constitutes a multi-state regional network.
(10) an intermodal plan describing how the new or improved corridor facilitates travel connections with other passenger transportation services;	How the improved corridor facilitates travel connections not directly addressed.	Available transportation services at stations is identified. Intermodal planning was completed early on, prior to 2006. Every transit agency had already rearranged bus lines to include the Cascades stations, and they intended to develop seamless transfers once there were constant headways on the train route. Seamless transit connections require frequent, reliable train schedules with constant headway, none of which were fully realized.

<p>(11) a description of the anticipated environmental benefits of the corridor; and</p>	<p>Benefits not described. Environmental impacts are discussed in general terms, but analysis is outdated.</p>	<p>The level that was required to qualify as a Programmatic EIS was met. Obviously analysis needs to be updated since 2006 to reflect current emissions reduction potential for train travel. Environmental benefits of rail transportation on the Cascades corridor can be easily cited. Ridership and revenue totals show the number of cars taken off the highway, CO2 reduction, particulate reduction, VMT reduction.</p> <p>The LRP Volume 5 Ridership and Revenue Forecasts has calculations for benefits.</p>
<p>(12) a description of the corridor's impacts on highway and aviation congestion, energy consumption, land use, and economic development in the service area.</p>	<p>Some of these topics are superficially addressed, but analysis is outdated.</p>	<p>These impacts were assessed at the time and just need to be updated to reflect current consumption, land use, and economic conditions. See above chart in item #11 extracted from Volume 5 Revenue and Ridership Forecasts. Also see Volume 6 Cross Modal Analysis, addressing aviation.</p>
<p>(13) Planning horizon should be closely correlated to the anticipated useful life of the capital investments required for the service.</p>	<p>Planning horizon was 2023 - outdated</p>	<p>The planning horizon was 2015, amended to 2018. Since that horizon was abandoned by WSDOT, the updated planning horizon should be set to 2035 for completion of all projects.</p>
<p>(14) Planning process should include extensive public participation</p>	<p>Planning process included minimal public participation</p>	<p>The team held numerous public meetings, and distributed hundreds of CD copies of the LRP to the public. Records of this public participation are no longer available.</p>
<p>(15) Planning process should include iterative alternatives analysis</p>	<p>No evidence of iterative alternatives analysis.</p>	<p>The iterative analysis occurred thirty years ago by design. The Long Range Plan for the Amtrak Cascades was and is the result of conducting an iterative analysis as cited in Technical Volume 1 Operating and Infrastructure Plan Appendix A.</p>
<p>(16) Social equity should be a consideration during alternative development and selection</p>	<p>Social equity not a consideration during alternative development.</p>	<p>Stations were already established since about 1908. Cities are located proximal to stations. Staying close to the existing railroad minimizes displacement of people. The environmental team had environmental justice specialists and history specialists to deal with those aspects. The service was planned for seamless transfer to transit to serve a broad and equitable range of communities. Social equity concerns should be updated with current community input as part of a regular process of updating the program. Additional reliability and frequency as well as reduced trip times on the corridor can be shown to benefit communities proximal to the corridor, especially as populations increase, and updates must plan to maximize ridership according to a high growth scenario.</p>

In order to better understand the scope of tax-payer funded study mandated by the WA state Legislature between 1993 and 2006, please see the following resources or visit <http://Solutionaryrail.org/20230208>:

1. A 55 minute interview with one of the primary authors of the Long Range Plan for the Amtrak Cascades, Thomas White,
2. Slides of the projects and timetables from the LRP,
3. Project Purpose and Timetables of the Long Range Plan for the Amtrak Cascades,
4. Proposed revisions to the WA State 2023-2025 Transportation Budget.

Further delaying long needed improvements to the Amtrak Cascades corridor in Washington State as outlined in the LRP, by failing to aggressively compete for funding made available by the Bipartisan Infrastructure Law and Inflation Reduction Act is inexcusable.

Tom White, a rail expert who worked on the AC-LRP described the mission that the Legislature gave the former rail office at WSDOT in this way: "Our mission in 1992 was to develop a service to get the maximum number of people off of highways onto a train. It was not a 'small', a 'medium' and a 'large plan' or anything like that. It was, 'We've got all these people on this highway. You figure out how to get 'em off. That should be the mission right now. And it isn't."

Solutionary Rail and our allies with the Rail Can't Wait campaign agree with those instructions of three decades ago. So, it seems, does the Washington State Legislature as communicated through its Climate Commitment Act (CCA), which urges actions to rapidly reduce emissions and VMT.

It is our assessment that this law is being misused to provide public subsidies to the development of a long term project called the "ultra" high speed rail. With a service date at least 25 years in the future, it is an inappropriate response to the ticking clock of the climate emergency, and ineligible for the CCA funds meant to address climate issues within the next decade. This misappropriation of CCA funds starves more appropriate projects such as implementation of the Amtrak Cascades Long Range Plan.

As public interest organizations pleading for use of rail in the interest of the public and the climate, we have been frustrated by the obfuscation and active undermining of those public interests by WSDOT. We have met with legislators, provided testimony, and even offered budget amendments. What we hear is that legislators have been instructed by WSDOT to ignore our pleas, and that we somehow lack credibility. It seems unlikely that a broad consensus of rail advocacy groups in WA state about - and frustration with WSDOT rail division's priorities and leadership is completely unfounded.

It is critical that Washington state not be left behind in the national push to improve and expand rail service and capacity for passengers and freight. They deserve their public agencies to aggressively pursue their interests. The disagreement between Washington's rail advocacy organizations and WSDOT needs to be resolved.



Appendix C - Capital Cost

This estimate is based on the LRP estimate sheet for the original Point Defiance project, which included a substantial amount of work between Lakeview and TR Jct. (the PDB-BNSF junction in Tacoma). See the summary (Table 7 page 40) for total cost including inflation and additional contingency.

Point Defiance Bypass Alignment Change

EARTHWORK																													
	UNITS	UNIT COST	QUANTITY	TOTAL	COMMENTS																								
<i>Embankment</i>	CY	\$20	166,667	\$ 3,333,333																									
<i>General Excavation</i>	CY	\$15	740,741	\$ 11,111,111																									
TRACK																													
<i>Track Construction</i>																													
New Track	TF	\$140	20,000	\$2,800,000																									
<i>Turnouts</i>																													
#24	EA	\$178,000	1	\$178,000																									
<i>Bridges</i>																													
Construct New Bridge at Sta MP 20	TF	\$11,000	9000	\$99,000,000	High speed flyover																								
Bridge Mounts Road	SF	\$150	6200	\$930,000																									
Remove Mounts Road	SF	\$30	1200	\$36,000																									
80-160' DPG	TF	\$20,000	1300	\$26,000,000	Nisqually River bridge																								
> 160' TRT	TF	\$30,000	500	\$15,000,000	Nisqually River bridge																								
RR SIGNALS																													
Per P.O. T.O.	EA	\$250,000	1	\$250,000																									
Per Mile	MI	\$750,000	3.50	\$2,625,000																									
RIGHT OF WAY																													
<i>Undeveloped</i>	AC	\$40,000	17	\$688,704																									
<table border="1" style="width: 100%; border-collapse: collapse;"> <tbody> <tr> <td style="width: 65%;">Construction</td> <td></td> <td></td> <td></td> <td style="text-align: right;">\$ 161,952,148</td> <td></td> </tr> <tr> <td>Administration, Management, Environmental & Contingency 63%</td> <td></td> <td></td> <td></td> <td style="text-align: right;">102,029,854</td> <td></td> </tr> <tr> <td>Subtotal</td> <td></td> <td></td> <td></td> <td style="text-align: right;">263,982,002</td> <td></td> </tr> <tr> <td>Total</td> <td></td> <td></td> <td></td> <td style="text-align: right;">263,982,002</td> <td></td> </tr> </tbody> </table>						Construction				\$ 161,952,148		Administration, Management, Environmental & Contingency 63%				102,029,854		Subtotal				263,982,002		Total				263,982,002	
Construction				\$ 161,952,148																									
Administration, Management, Environmental & Contingency 63%				102,029,854																									
Subtotal				263,982,002																									
Total				263,982,002																									

Hannaford to Nisqually Third and Fourth Main Track (MP 24.1 - MP 51.4)

	UNITS	UNIT COST	QUANTITY	TOTAL	COMMENTS
EARTHWORK					
<i>Clear & Grub</i>	AC	\$4,000		\$ -	
<i>Common Excavation</i>	CY	\$10		\$ -	
<i>Rock Excavation</i>	CY	\$50		\$ -	
<i>Embankment</i>	CY	\$20		\$ -	
<i>General Excavation *</i>	CY	\$15	1578472	\$ 23,677,080	
<i>Subballast</i>	CY	\$30		\$ -	
<i>Erosion Controls</i>	LS	\$0		\$ -	
<i>Seeding</i>	AC	\$2,500		\$ -	
<i>Place Topsoil</i>	CY	\$25		\$ -	
<i>Tunnel</i>	MI	\$0		\$ -	
				\$ -	
				\$ -	
				\$ -	
TRACK					
Track Construction					
New Track	TF	\$140	225496	\$ 31,569,440	
Rehab Track	TF	\$100		\$ -	
Yard Track	TF	\$125		\$ -	
Lineover Track	TF	\$25		\$ -	
				\$ -	
Track/Turnout Removal/Relocation					
Remove Existing Track	TF	\$10	20700	\$ 207,000	Bucoda & Tenino sidings and Nisqually relocation
Relocate Existing Track	TF	\$100	5000	\$ 500,000	Nisqually relocation
Remove Existing Turnout	EA	\$5,000	5	\$ 25,000	
Relocate Existing Turnout	EA	\$35,000		\$ -	
Remove Existing Crossover	EA	\$10,000	1	\$ 10,000	
Relocate Existing Crossover	EA	\$70,000	1	\$ 70,000	
				\$ -	
Turnouts					
Split Point Derail	EA	\$45,000		\$ -	
#9	EA	\$110,000		\$ -	
#11	EA	\$120,000		\$ -	
#15	EA	\$142,000		\$ -	
#20	EA	\$168,000		\$ -	
#24	EA	\$178,000	3	\$ 534,000	
#33	EA	\$360,000	1	\$ 360,000	
#48	EA	\$500,000	1	\$ 500,000	
Crossovers					
#9	EA	\$230,000		\$ -	
#11	EA	\$250,000		\$ -	
#15	EA	\$285,000		\$ -	
#20	EA	\$336,000		\$ -	
#24	EA	\$355,000	2	\$ 710,000	
#33	EA	\$730,000	1	\$ 730,000	
#48	EA	\$1,010,000		\$ -	
Bridges					
< 32' PRCT	TF	\$5,000	671	\$ 3,355,000	MP 45.63 3 - 16' RCT (2 tracks); MP 40.17 105' PT (2 tracks); MP 39.14 71' RCT (2 tracks); MP 33.56 5 - 15' BDPT (1 track); MP 31.60 4 - 28' CBG (1 track); MP 26.13 20' CA; MP 42.65 10' CA (2 tracks) and MP 40.27 8' CA (2 tracks)
32- 45' PRCT	TF	\$6,500	84	\$ 546,000	MP 39.57 42' IB
45-80' IB	TF	\$9,000		\$ -	
80-160' DPG	TF	\$20,000	6532	\$ 130,640,000	MP 43.09 2 - 101' DPG (2 tracks); MP 42.77 2 - 65' DPG (2 tracks); MP 36.15 2 - 110' DPG, DRT (1 track); MP 30.75 2 - 124' WF (1 track); MP 25.38 900' Nisqually River 3-track bridge
80-160' TPG	TF	\$20,000	288	\$ 5,760,000	MP 47.38 144' TRT (2 tracks)
> 160' TRT	TF	\$30,000	900	\$ 27,000,000	MP 25.38 300' Nisqually River 3-track bridge
Remove Existing Bridge	TF	\$500		\$ -	
Remove Existing Bridge **	TF	\$3,300	1314	\$ 4,336,200	MP 25.38 Existing Nisqually River Bridge (2 tracks)
				\$ -	
Culvert Crossings					
Major Culverts (> 36" Diameter)	LF	\$600	30	\$ 18,000	
Minor Culverts (< 36" Diameter)	LF	\$100	1500	\$ 150,000	
				\$ -	
Other Drainage					
	LS	\$0		\$ -	
Retaining Walls					
C.I.P.	SF	\$75		\$ -	
Soldier Pile < 20'	SF	\$75		\$ -	
Soldier Pile w/ Tie Back > 20'	SF	\$100		\$ -	
Soil Nail	SF	\$55		\$ -	

Hannaford to Nisqually Third and Fourth Main Track (MP 24.1 - MP 51.4)

	UNITS	UNIT COST	QUANTITY	TOTAL	COMMENTS
Retaining Walls	LF	\$1,000	1000	\$ 1,000,000	type unknown
Station Platform	LS	\$2,500,000	2	\$ 5,000,000	Centennial
Demo existing station platform **	LS	\$50,000	1	\$ 50,000	Centennial
				\$ -	
ROADWAY					
Roadway Construction	SY	\$60		\$ -	
At-Grade Crossing					
Concrete Crossing Panels Installed	TF	\$800	1110	\$ 888,000	
Urban Major Crossing Approaches	SY	\$75		\$ -	MP 49.17 Connor Rd.°; MP 46.75°; MP 45.30 184th St. S.E.°; MP 41.10 McDuff Rd.°; MP 36.55 S. Rich Rd.°; MP 34.84
Urban Minor Crossing Approaches	SY	\$75	2800	\$ 210,000	N. Rich Rd.°; MP 31.42 Atchison Rd.°; MP 29.94 Marvin Rd.°
Rural Major Crossing Approaches	SY	\$75		\$ -	
Rural Minor Crossing Approaches	SY	\$75	1925	\$ 144,375	Private GXs MP 50.78 ⁰⁰ , MP 48.47 ⁰⁰ , MP 42.43 ⁰⁰ , MP 37.02 ⁰⁰ , MP 36.01 ⁰⁰ , MP 27.65 ⁰⁰ , MP 26.39 ⁰⁰ , MP 24.68 ⁰⁰
				\$ -	
Grade-Separation Crossing					
Bridge	SF	\$150		\$ -	
Roadway (earthwork & paving)	SY	\$50		\$ -	
MSE Wall	SF	\$40		\$ -	
Embankment (fill)	CY	\$25		\$ -	
Misc. (non-typical per project)	LS	\$1		\$ -	
Crash wall **	LF	\$300	40	\$ 12,000	MP 26.84 Reservation Rd.
Crossing Signals					
Upgrade Signal - Barrier Gates	EA	\$200,000	12	\$ 2,400,000	° - Upgraded signals
New Signal	EA	\$250,000	8	\$ 2,000,000	⁰⁰ - New signals
				\$ -	
RR SIGNALS					
Per P.O. T.O.	EA	\$250,000	13	\$ 3,250,000	
Per Mile	MI	\$750,000	42.71	\$ 32,030,682	
Electric Locks	EA	\$25,000		\$ -	
				\$ -	
UTILITY RELOCATION/ADJUSTMENT					
Transmission Lines	LS	\$1		\$ -	
Fiber Optic Lines	LF	\$95		\$ -	
Miscellaneous	LS	\$1		\$ -	
				\$ -	
CONTINGENCIES (30%)	LS		30%	\$ 83,304,833	
				CONSTRUCTION TOTAL \$ 360,987,610	
ENVIRONMENTAL MITIGATION (20%)	LS		20%	\$ 72,197,522	
Wetland Compensation	AC	\$0		\$ -	
				SUBTOTAL \$ 433,185,132	
ENGINEERING/ADMINISTRATION (7%)	LS		7%	\$ 25,269,133	
CONSTRUCTION MANAGEMENT (6%)	LS		6%	\$ 21,659,257	
RIGHT OF WAY					
Undeveloped	AC	\$20,000	12.42	\$ 248,400	
Residential	AC	\$100,000	25	\$ 2,500,000	
Commercial	AC	\$250,000		\$ -	
Industrial	AC	\$350,000		\$ -	
				\$ -	
TAX (8.2%)			8.2%	\$ 29,600,984	
TOTAL				\$ 512,462,905	

Assumptions:

Two New Tracks
 One New Track
 Three New Tracks

(MP 50.8 to MP 36.25)
 (MP 36.25 to MP 26.14)
 (MP 26.14 to MP 24.98)

Track Miles

29.10
 10.11
 3.50
42.71

\$11,999,344 / mile

Private Crossings are to be closed or equiped with auto gates.

* General Excavation includes a fill section of 5' x 25' for 75% of the time and a cut section of 10' x 25' for 25% of the time

** Note: Unit costs based upon typical cost of similar projects and may vary from those in the conceptual estimates for other projects.

Chehalis to Hannaford Third Main Track (MP 51.4 - MP 59.5)

	UNITS	UNIT COST	QUANTITY	TOTAL	COMMENTS
EARTHWORK					
<i>Clear & Grub</i>	AC	\$4,000		\$ -	
<i>Common Excavation</i>	CY	\$10		\$ -	
<i>Rock Excavation</i>	CY	\$50		\$ -	
<i>Embankment</i>	CY	\$20		\$ -	
<i>General Excavation *</i>	CY	\$15	225456	\$ 3,381,840	
<i>Subballast</i>	CY	\$30		\$ -	
<i>Erosion Controls</i>	LS	\$0		\$ -	
<i>Seeding</i>	AC	\$2,500		\$ -	
<i>Place Topsoil</i>	CY	\$25		\$ -	
<i>Tunnel</i>	MI	\$0		\$ -	
				\$ -	
				\$ -	
TRACK					
Track Construction					
New Track	TF	\$140	32208	\$ 4,509,120	
Rehab Track	TF	\$100	6864	\$ 686,400	
Yard Track	TF	\$125		\$ -	
Lineover Track	TF	\$25		\$ -	
				\$ -	
Track/Turnout Removal/Relocation					
Remove Existing Track	TF	\$10		\$ -	
Relocate Existing Track	TF	\$100		\$ -	
Remove Existing Turnout	EA	\$5,000	2	\$ 10,000	
Relocate Existing Turnout	EA	\$35,000		\$ -	
Remove Existing Crossover	EA	\$10,000	3	\$ 30,000	
Relocate Existing Crossover	EA	\$70,000		\$ -	
				\$ -	
Turnouts					
Split Point Derail	EA	\$45,000		\$ -	
#9	EA	\$110,000		\$ -	
#11	EA	\$120,000		\$ -	
#15	EA	\$142,000	4	\$ 568,000	
#20	EA	\$168,000		\$ -	
#24	EA	\$178,000	1	\$ 178,000	
#33	EA	\$360,000	1	\$ 360,000	
#48	EA	\$500,000		\$ -	
Crossovers					
#9	EA	\$230,000		\$ -	
#11	EA	\$250,000		\$ -	
#15	EA	\$285,000	0	\$ -	
#20	EA	\$336,000	1	\$ 336,000	
#24	EA	\$355,000	5	\$ 1,775,000	
#33	EA	\$730,000		\$ -	
#48	EA	\$1,010,000		\$ -	
Bridges					
< 32' PRCT	TF	\$5,000	120	\$ 600,000	MP 55.86 4 - 30' WF
32- 45' PRCT	TF	\$6,500		\$ -	
45-80' IB	TF	\$9,000	326	\$ 2,934,000	MP 58.65 224' CTG; MP 51.87 2 - 51' WF(SH)
80-160' DPG	TF	\$20,000		\$ -	
80-160' TPG	TF	\$20,000	103	\$ 2,060,000	MP 59.49 103' TPG
> 160' TRT	TF	\$30,000		\$ -	
Remove Existing Bridge	TF	\$500		\$ -	
				\$ -	
				\$ -	
Culvert Crossings					
Major Culverts (> 36" Diameter)	LF	\$600	90	\$ 54,000	
Minor Culverts (< 36" Diameter)	LF	\$100	240	\$ 24,000	
				\$ -	
Other Drainage					
	LS	\$0		\$ -	
Retaining Walls					
C.I.P.	SF	\$75		\$ -	
Soldier Pile < 20'	SF	\$75		\$ -	
Soldier Pile w/ Tie Back > 20'	SF	\$100		\$ -	
Soil Nail	SF	\$55		\$ -	
				\$ -	
Station Platform	LS	\$2,500,000	1	\$ 2,500,000	25x1000', grade separate pedestrian crossing
				\$ -	
				\$ -	
ROADWAY					
Roadway Construction	SY	\$60		\$ -	

Chehalis to Hannaford Third Main Track (MP 51.4 - MP 59.5)

	UNITS	UNIT COST	QUANTITY	TOTAL	COMMENTS
At-Grade Crossing					
Concrete Crossing Panels Installed	TF	\$800	650	\$ 520,000	Public GXs MP 58.01 Main St. ^o ; MP 57.93 Center St. ^o ; MP 57.88 Prindle St. ^o ; MP 57.65 West St. ^o ; MP 55.18 Floral Ave. ^o ; MP 54.82 W. Summa St. ^o ; MP 54.60 (pedestrian xing only) ^{oo} ; MP 54.44 (pedestrian xing only) ^{oo} ; MP 54.17 Locust St. ^o ; MP 54.10 Main St. ^o ; MP 53.90 Maple St. ^o ; MP 51.39 ^o ; Private GX MP 50.78 ^{oo}
Urban Major Crossing Approaches	SY	\$75		\$ -	
Urban Minor Crossing Approaches	SY	\$75	3500	\$ 262,500	
Rural Major Crossing Approaches	SY	\$75		\$ -	
Rural Minor Crossing Approaches	SY	\$75	175	\$ 13,125	
				\$ -	
Grade-Separation Crossing					
Bridge	SF	\$150		\$ -	
Roadway (earthwork & paving)	SY	\$50		\$ -	
MSE Wall	SF	\$40		\$ -	
Embankment (fill)	CY	\$25		\$ -	
Misc. (non-typical per project)	LS	\$1		\$ -	
				\$ -	
Crossing Signals					
Upgrade Signal - Barrier Gates	EA	\$200,000	18	\$ 3,600,000	^o - Upgraded signals
New Signal	EA	\$250,000	3	\$ 750,000	^{oo} - New signals
				\$ -	
RR SIGNALS					
Per P.O. T.O.	EA	\$250,000	18.5	\$ 4,625,000	
Per Mile	MI	\$750,000	8.70	\$ 6,525,000	
Electric Locks	EA	\$25,000		\$ -	
				\$ -	
UTILITY RELOCATION/ADJUSTMENT					
Transmission Lines	LS	\$1		\$ -	
Fiber Optic Lines	LF	\$95		\$ -	
Miscellaneous	LS	\$1		\$ -	
				\$ -	
CONTINGENCIES (30%)	LS		30%	\$ 10,890,596	
			CONSTRUCTION TOTAL	\$ 47,192,581	
ENVIRONMENTAL MITIGATION (20%)	LS		20%	\$ 9,438,516	
Wetland Compensation	AC	\$0		\$ -	
			SUBTOTAL	\$ 56,631,097	
ENGINEERING/ADMINISTRATION (7%)	LS		7%	\$ 3,303,481	
CONSTRUCTION MANAGEMENT (6%)	LS		6%	\$ 2,831,555	
RIGHT OF WAY					
Undeveloped	AC	\$20,000	0.61	\$ 12,200	
Residential	AC	\$100,000		\$ -	
Commercial	AC	\$250,000		\$ -	
Industrial	AC	\$350,000		\$ -	
				\$ -	
TAX (8.2%)			8.2%	\$ 3,869,792	
TOTAL				\$ 66,648,124	

Assumptions:
 One New Track
 Rehab Siding

	Track Miles
(MP 50.8 to MP 59.5)	7.40
(MP 52.3 to MP 53.6)	1.30
	<u>8.70</u>

\$7,660,704 / mile

* General Excavation includes a fill section of 5' x 25' for 75% of the time and a cut section of 10' x 25' for 25% of the time

Note: property for the Centralia station was sold and developed after 2006. Projects total on page () includes an additional \$15 million for property acquisition.

Chehalis Siding (MP 56.8 - MP 58.3)

	UNITS	UNIT COST	QUANTITY	TOTAL	COMMENTS
EARTHWORK					
<i>Clear & Grub</i>	AC	\$4,000		\$ -	
<i>Common Excavation</i>	CY	\$10		\$ -	
<i>Rock Excavation</i>	CY	\$50		\$ -	
<i>Embankment</i>	CY	\$20		\$ -	
<i>General Excavation *</i>	CY	\$15	55440	\$ 831,600	
<i>Subballast</i>	CY	\$30		\$ -	
<i>Erosion Controls</i>	LS	\$0		\$ -	
<i>Seeding</i>	AC	\$2,500		\$ -	
<i>Place Topsoil</i>	CY	\$25		\$ -	
<i>Tunnel</i>	MI	\$0		\$ -	
				\$ -	
				\$ -	
				\$ -	
TRACK					
Track Construction					
New Track	TF	\$140	7920	\$ 1,108,800	
Rehab Track	TF	\$100		\$ -	
Yard Track	TF	\$125		\$ -	
Lineover Track	TF	\$25		\$ -	
				\$ -	
Track/Turnout Removal/Relocation					
Remove Existing Track	TF	\$10	2640	\$ 26,400	
Relocate Existing Track	TF	\$100		\$ -	
Remove Existing Turnout	EA	\$5,000	2	\$ 10,000	
Relocate Existing Turnout	EA	\$35,000	2	\$ 70,000	
Remove Existing Crossover	EA	\$10,000		\$ -	
Relocate Existing Crossover	EA	\$70,000		\$ -	
				\$ -	
				\$ -	
Turnouts					
Split Point Derail #9	EA	\$45,000	1	\$ 45,000	#11 POTO at south end doubles as second derail
	EA	\$110,000		\$ -	
#11	EA	\$120,000	1	\$ 120,000	Include with south end CP to double as a derail
#15	EA	\$142,000	2	\$ 284,000	
#20	EA	\$168,000		\$ -	
#24	EA	\$178,000		\$ -	
#33	EA	\$360,000		\$ -	
#48	EA	\$500,000		\$ -	
Crossovers					
#9	EA	\$230,000		\$ -	
#11	EA	\$250,000		\$ -	
#15	EA	\$285,000		\$ -	
#20	EA	\$336,000		\$ -	
#24	EA	\$355,000		\$ -	
#33	EA	\$730,000		\$ -	
#48	EA	\$1,010,000		\$ -	
Bridges					
< 32' PRCT	TF	\$5,000		\$ -	
32- 45' PRCT	TF	\$6,500		\$ -	
45-80' IB	TF	\$9,000		\$ -	
80-160' DPG	TF	\$20,000		\$ -	
80-160' TPG	TF	\$20,000		\$ -	
> 160' TRT	TF	\$30,000		\$ -	
Remove Existing Bridge	TF	\$500		\$ -	
				\$ -	
				\$ -	
Culvert Crossings					
Major Culverts (> 36" Diameter)	LF	\$600		\$ -	
Minor Culverts (< 36" Diameter)	LF	\$100	60	\$ 6,000	
				\$ -	
				\$ -	
Other Drainage					
	LS	\$0		\$ -	
Retaining Walls					
C.I.P.	SF	\$75		\$ -	
Soldier Pile < 20'	SF	\$75		\$ -	
Soldier Pile w/ Tie Back > 20'	SF	\$100		\$ -	
Soil Nail	SF	\$55		\$ -	
				\$ -	
				\$ -	
Station Platform	LS	\$2,500,000		\$ -	
				\$ -	
				\$ -	
ROADWAY					
Roadway Construction	SY	\$60		\$ -	

Chehalis Siding (MP 56.8 - MP 58.3)

	UNITS	UNIT COST	QUANTITY	TOTAL	COMMENTS
At-Grade Crossing					
Concrete Crossing Panels Installed	TF	\$800	600	\$ 480,000	Public GXs MP 58.01 Main St. ^o ; MP 57.93 Center St. ^o ; MP 57.88 Prindle St. ^o ; MP 57.65 West St. ^o
Urban Major Crossing Approaches	SY	\$75		\$ -	
Urban Minor Crossing Approaches	SY	\$75	3500	\$ 262,500	
Rural Major Crossing Approaches	SY	\$75		\$ -	
Rural Minor Crossing Approaches	SY	\$75		\$ -	
				\$ -	
Grade-Separation Crossing					
Bridge	SF	\$150		\$ -	
Roadway (earthwork & paving)	SY	\$50		\$ -	
MSE Wall	SF	\$40		\$ -	
Embankment (fill)	CY	\$25		\$ -	
Misc. (non-typical per project)	LS	\$1		\$ -	
				\$ -	
Crossing Signals					
Upgrade Signal - Barrier Gates	EA	\$200,000	4	\$ 800,000	^o - Upgraded signals
New Signal	EA	\$250,000	0	\$ -	^{oo} - New signals
				\$ -	
RR SIGNALS					
Per P.O. T.O.	EA	\$250,000	4	\$ 1,000,000	
Per Mile	MI	\$750,000	1.50	\$ 1,125,000	
Electric Locks	EA	\$25,000		\$ -	
				\$ -	
UTILITY RELOCATION/ADJUSTMENT					
<i>Transmission Lines</i>	LS	\$1		\$ -	
<i>Fiber Optic Lines</i>	LF	\$95		\$ -	
<i>Miscellaneous</i>	LS	\$1		\$ -	
				\$ -	
CONTINGENCIES (30%)	LS		30%	\$ 1,850,790	
			CONSTRUCTION TOTAL	\$ 8,020,090	
ENVIRONMENTAL MITIGATION (20%)	LS		20%	\$ 1,604,018	
<i>Wetland Compensation</i>	AC	\$0		\$ -	
			SUBTOTAL	\$ 9,624,108	
ENGINEERING/ADMINISTRATION (7%)	LS		7%	\$ 561,406	
CONSTRUCTION MANAGEMENT (6%)	LS		6%	\$ 481,205	
RIGHT OF WAY					
<i>Undeveloped</i>	AC	\$20,000		\$ -	
<i>Residential</i>	AC	\$100,000		\$ -	
<i>Commercial</i>	AC	\$250,000		\$ -	
<i>Industrial</i>	AC	\$350,000		\$ -	
				\$ -	
TAX (8.2%)			8.2%	\$ 657,647	
TOTAL				\$ 11,324,367	

Assumptions:

Extend Chehalis Siding (MP 56.8 to MP 58.3) Track Miles 1.50 \$7,549,578 / mile

* General Excavation includes a fill section of 5' x 25' for 75% of the time and a cut section of 10' x 25' for 25% of the time

Chehalis Crossover (MP 57.7)

	UNITS	UNIT COST	QUANTITY	TOTAL	COMMENTS
EARTHWORK					
<i>Clear & Grub</i>	AC	\$4,000		\$ -	
<i>Common Excavation</i>	CY	\$10	5200	\$ 52,000	
<i>Rock Excavation</i>	CY	\$50		\$ -	
<i>Embankment</i>	CY	\$20	5200	\$ 104,000	
<i>General Excavation *</i>	CY	\$15		\$ -	
<i>Subballast</i>	CY	\$30		\$ -	
<i>Erosion Controls</i>	LS	\$0		\$ -	
<i>Seeding</i>	AC	\$2,500		\$ -	
<i>Place Topsoil</i>	CY	\$25		\$ -	
<i>Tunnel</i>	MI	\$0		\$ -	
				\$ -	
				\$ -	
				\$ -	
TRACK					
<i>Track Construction</i>					
New Track	TF	\$140		\$ -	
Rehab Track	TF	\$100		\$ -	
Yard Track	TF	\$125		\$ -	
Lineover Track	TF	\$25		\$ -	
				\$ -	
<i>Track/Turnout Removal/Relocation</i>					
Remove Existing Track	TF	\$10		\$ -	
Relocate Existing Track	TF	\$100		\$ -	
Remove Existing Turnout	EA	\$5,000	4	\$ 20,000	
Relocate Existing Turnout	EA	\$35,000		\$ -	
Remove Existing Crossover	EA	\$10,000		\$ -	
Relocate Existing Crossover	EA	\$70,000		\$ -	
				\$ -	
<i>Turnouts</i>					
Split Point Derail	EA	\$45,000		\$ -	
#9	EA	\$110,000		\$ -	
#11	EA	\$120,000		\$ -	
#15	EA	\$142,000		\$ -	
#20	EA	\$168,000		\$ -	
#24	EA	\$178,000		\$ -	
#33	EA	\$360,000		\$ -	
#48	EA	\$500,000		\$ -	
<i>Crossovers</i>					
#9	EA	\$230,000		\$ -	
#11	EA	\$250,000		\$ -	
#15	EA	\$285,000		\$ -	
#20	EA	\$336,000		\$ -	
#24	EA	\$355,000	2	\$ 710,000	
#33	EA	\$730,000		\$ -	
#48	EA	\$1,010,000		\$ -	
<i>Bridges</i>					
< 32' PRCT	TF	\$5,000		\$ -	
32- 45' PRCT	TF	\$6,500		\$ -	
45-80' IB	TF	\$9,000		\$ -	
80-160' DPG	TF	\$20,000		\$ -	
80-160' TPG	TF	\$20,000		\$ -	
> 160' TRT	TF	\$30,000		\$ -	
Remove Existing Bridge	TF	\$500		\$ -	
				\$ -	
				\$ -	
<i>Culvert Crossings</i>					
Major Culverts (> 36" Diameter)	LF	\$600		\$ -	
Minor Culverts (< 36" Diameter)	LF	\$100		\$ -	
				\$ -	
<i>Other Drainage</i>					
	LS	\$0		\$ -	
<i>Retaining Walls</i>					
C.I.P.	SF	\$75		\$ -	
Soldier Pile < 20'	SF	\$75		\$ -	
Soldier Pile w/ Tie Back > 20'	SF	\$100		\$ -	
Soil Nail	SF	\$55		\$ -	
				\$ -	
<i>Station Platform</i>					
	LS	\$2,500,000		\$ -	
				\$ -	
				\$ -	
ROADWAY					
<i>Roadway Construction</i>					
	SY	\$60		\$ -	
<i>At-Grade Crossing</i>					
Concrete Crossing Panels Installed	TF	\$800		\$ -	
Urban Major Crossing Approaches	SY	\$75		\$ -	
Urban Minor Crossing Approaches	SY	\$75		\$ -	
Rural Major Crossing Approaches	SY	\$75		\$ -	
Rural Minor Crossing Approaches	SY	\$75		\$ -	
				\$ -	
<i>Grade-Separation Crossing</i>					

Chehalis Crossover (MP 57.7)

	UNITS	UNIT COST	QUANTITY	TOTAL	COMMENTS
Bridge	SF	\$150		\$ -	
Roadway (earthwork & paving)	SY	\$50		\$ -	
MSE Wall	SF	\$40		\$ -	
Embankment (fill)	CY	\$25		\$ -	
Misc. (non-typical per project)	LS	\$1		\$ -	
				\$ -	
Crossing Signals					
Upgrade Signal - Barrier Gates	EA	\$200,000		\$ -	
New Signal	EA	\$250,000		\$ -	
				\$ -	
RR SIGNALS					
Per P.O. T.O.	EA	\$250,000	4	\$ 1,000,000	
Per Mile	MI	\$750,000		\$ -	
Electric Locks	EA	\$25,000		\$ -	
				\$ -	
UTILITY RELOCATION/ADJUSTMENT					
<i>Transmission Lines</i>	LS	\$1		\$ -	
<i>Fiber Optic Lines</i>	LF	\$95		\$ -	
<i>Miscellaneous</i>	LS	\$1		\$ -	
				\$ -	
CONTINGENCIES (30%)	LS		30%	\$ 565,800	
			CONSTRUCTION TOTAL	\$ 2,451,800	
ENVIRONMENTAL MITIGATION (20%)	LS		20%	\$ 490,360	
<i>Wetland Compensation</i>	AC	\$0		\$ -	
			SUBTOTAL	\$ 2,942,160	
ENGINEERING/ADMINISTRATION (7%)	LS		7%	\$ 171,626	
CONSTRUCTION MANAGEMENT (6%)	LS		6%	\$ 147,108	
RIGHT OF WAY					
<i>Undeveloped</i>	AC	\$20,000		\$ -	
<i>Residential</i>	AC	\$100,000		\$ -	
<i>Commercial</i>	AC	\$250,000		\$ -	
<i>Industrial</i>	AC	\$350,000		\$ -	
				\$ -	
TAX (8.2%)			8.2%	\$ 201,048	
TOTAL				\$ 3,461,942	

Assumptions:

* General Excavation includes a fill section of 5' x 25' for 75% of the time and a cut section of 10' x 25' for 25% of the time



Appendix D Tilting Trains

The 1983 and 1991 high speed ground transportation studies recommended tilting trains as part of Amtrak improvements in the corridor. Tilting trains allow higher speed in curves than non-tilting (standard) trains.



Most people are familiar with superelevated (commonly called “banked”) highway curves. They allow higher speed through the curve than a flat road because they limit the ability of centrifugal force to fling the car laterally off the road. The speed limit is determined by the amount that tire friction resists centrifugal force and the amount that superelevation causes gravity to assist in resisting centrifugal force.

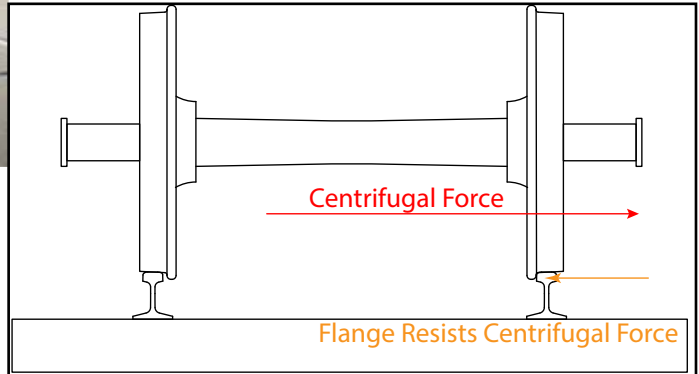

Railroad track is also superelevated but for a different reason. The flanges on the wheels prevent centrifugal force from making the wheels slide sideways. Railroad cars may have a high center of gravity. They are more susceptible to centrifugal force as an overturning force.

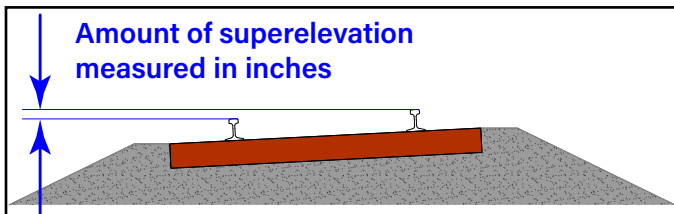

Superelevation of railroad track counteracts the tendency of centrifugal force to overturn a train rather than cause it to slide sideways.

The maximum speed for a curve is determined by a formula published in the Code of Federal Regulations, 49 CFR 213.329. The formula includes an amount for unbalanced superelevation, generally called unbalance. It may be called cant deficiency. That is the acceptable amount of superelevation greater than the actual measured superelevation.

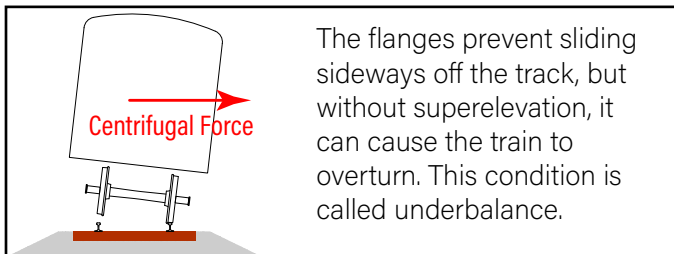

The flanges prevent sliding sideways off the track, but without superelevation, it can cause the train to overturn. This condition is called underbalance.

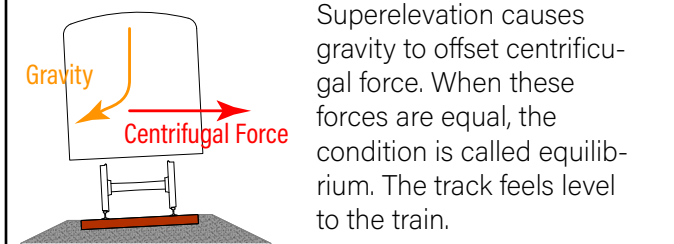

Superelevation causes gravity to offset centrifugal force. When these forces are equal, the condition is called equilibrium. The track feels level to the train.

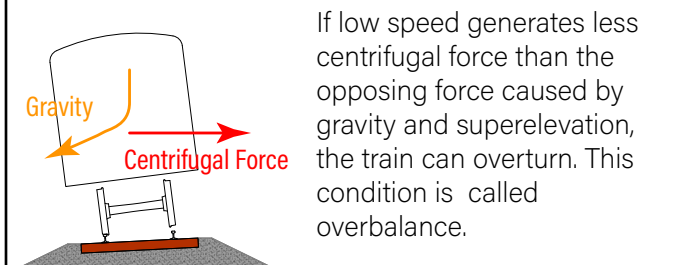

If low speed generates less centrifugal force than the opposing force caused by gravity and superelevation, the train can overturn. This condition is called overbalance.

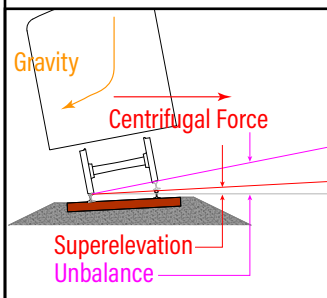

The posted maximum speed is generally a multiple of 5 mph (e.g., 5, 10, 15, 20). That is merely custom. The posted speed may be the amount calculated by the formula. Speed limits for Amtrak Cascades trains between the US-Canada border and Portland are posted rounded to the nearest 1 mph. A short, light

train can make use of the difference, which is, for example, worth about seven minutes in travel time reduction between Seattle and Portland.

The maximum speed for freight trains is generally calculated using two inches of unbalance as a track maintenance cost consideration. At less than two inches of unbalance, the infrastructure cost for a commercially desirable cost can be high, either in superelevation or wider radius curves. At more than two inches, track maintenance cost increases as the heavy freight cars push laterally on the inner (low) rail of the curve.

Passenger train speed limits are calculated at three inch unbalance, the maximum allowed for cars that have not been tested to be safe for greater unbalance.

Passenger cars are tested for the ability to operate at greater unbalance by leaning them to one side and measuring the difference in the weight on the high side wheels when the car is flat and when it is tilted. This test determines the safe amount of unbalance without overturning. Most Amtrak cars are allowed four or five inches of unbalance.

However, in a passenger train, overturning is not the only consideration. Centrifugal force that is not enough to overturn the car may be uncomfortable or unsafe for passengers as the centrifugal force pushes them sideways.

The allowable amount of unbalance by regulation determines whether the car is safe from overturning, but not passenger comfort at maximum allowed unbalance speed. The ride characteristics of individual car types must be considered when determining the maximum curve speeds in commercial use.

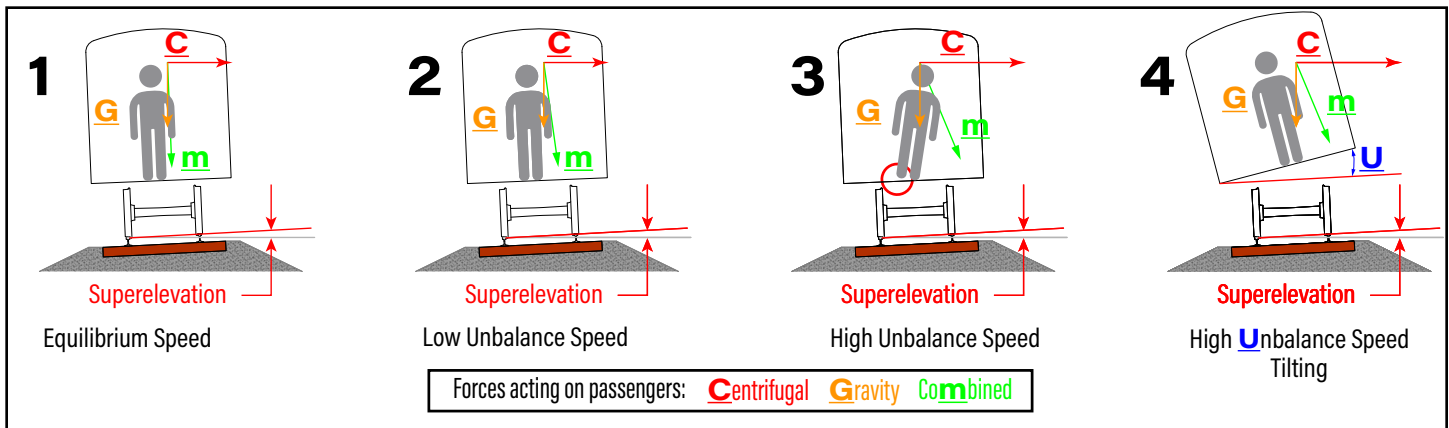

- 1 - At equilibrium speed, the combined centrifugal and gravitational forces are perpendicular to the floor.
- 2 - Passengers can feel uncomfortable if their eyes tell them the train is turning and their body tells them the train is going straight, so a small amount of underbalance is common.
- 3 - At a higher unbalance speed, passengers may be pushed toward the outside of the curve, with increasing severity as unbalance increases.
- 4 - The tilting carbody compensates for the unbalance, returning the forces on the passengers to near those of equilibrium.

The Talgo trains used in Amtrak Cascades service are capable of eight inch unbalance. When the first Talgo sets were operating in demonstration service between Seattle and Portland, they were subject to extensive testing to determine the maximum amount of unbalance that would be allowed in calculating maximum speed through curves. The trains had an F59PH locomotive made by EMD (Electro Motive Division of General Motors), and a cab car to allow the engineer to control the locomotive from the opposite end of the train. The cab car was a converted EMD F40 locomotive that had the diesel engine, generator, motors, and other equipment removed.

Speed Restriction curves between Vancouver BC and Portland

Superelevation	Shared Track Ea 5"				Exclusive Track Ea 6.5"								
	3" Eu	5" Eu	3" Eu	5" Eu	3" Eu	5" Eu	8" Eu	3" Eu	5" Eu	8" Eu	3" Eu	5" Eu	8" Eu
Unbalance	3" Eu	5" Eu	3" Eu	5" Eu	3" Eu	5" Eu	8" Eu	3" Eu	5" Eu	8" Eu	3" Eu	5" Eu	8" Eu
Max Speed	79	79	90	90	79	79	79	90	90	90	110	110	110
Unrestricted Curve Degrees	1.831	2.889	1.411	1.764	2.174	2.633	3.322	1.676	2.028	2.56	1.222	1.358	1.712
Total Curves	176	176	176	176	176	176	176	176	176	176	176	176	176
Restricted Curves	123	87	136	124	109	93	74	127	118	96	143	137	126
Not Restricted Curves	53	89	40	52	67	83	102	49	58	80	33	39	50
Percent Restricted	70%	49%	77%	70%	62%	53%	42%	72%	67%	55%	81%	78%	72%
Percent Not Restricted	30%	51%	23%	30%	38%	47%	58%	28%	33%	45%	19%	22%	28%

The testing revealed that the Talgo cars were within the required tolerance when running at seven inch unbalance speed. However, the locomotive and cab car were unstable at more than six inches. BN would not allow six inch

Table 6

unbalance speed. They wanted an inch of leeway in the track condition so that less maintenance would be required to prevent a speed restriction because of track condition. The extra tolerance notwithstanding, the Talgo trains were subject to several speed restrictions because of track condition.

The Horizon cars currently in use on the Amtrak Cascades trains and the Airo cars that have been purchased for the service are authorized to operate at curve speed limits calculated using five inches unbalance. Thus, they can operate at the posted Talgo train speed limits. Given suitable locomotive, cab car, and track conditions, tilting trains can make a substantial contribution to Amtrak Cascades service. However, since a fleet of new equipment has been purchased, the need to re-align additional curves must be accepted.

Table 6 (page 40) is a summary of all curves between Vancouver BC and Portland. The left set of columns represents the maximum superelevation for shared passenger and freight track. Railroads prefer the least amount of superelevation possible for the desired speed. Low superelevation reduces maintenance cost. It also reduces or eliminates the tendency of very heavy cars to push the lower rail to the inside of the curve. It also reduces the possibility that high center of gravity heavy freight cars in a slow moving train will overturn in the curve. Between Vancouver BC and Portland, maximum superelevation is five inches.

The right set of columns represents a dedicated passenger track. FRA allows a maximum of seven inches superelevation. The table is calculated for 6.5 inches to allow a half inch for track surface irregularities without a penalty for exceeding the limit.

In the table, the symbol E_a means actual superelevation of the track; E_u represents unbalance.

The table has columns for 3" E_u trains, conventional Amtrak cars, and 5" E_u trains on shared track. There are columns for 3", 5", and 8" tilting trains on exclusive passenger track. This is an end to end summary, so many of the curves with a speed limit of less than 79 mph are in a location where a lower speed is acceptable or unavoidable. When those conditions are excluded, tilting trains can make a substantial difference in the need to re-align curves for higher speed.

The example at right shows the geometry of a 90 degree of central angle 110 mph curve for 5 inch and eight inch unbalance trains. The curve length is 1,338 feet greater for the 5" E_u curve than the 8" E_u curve. Assuming a 100 foot wide right of way, the land area difference is 3.1 acres.

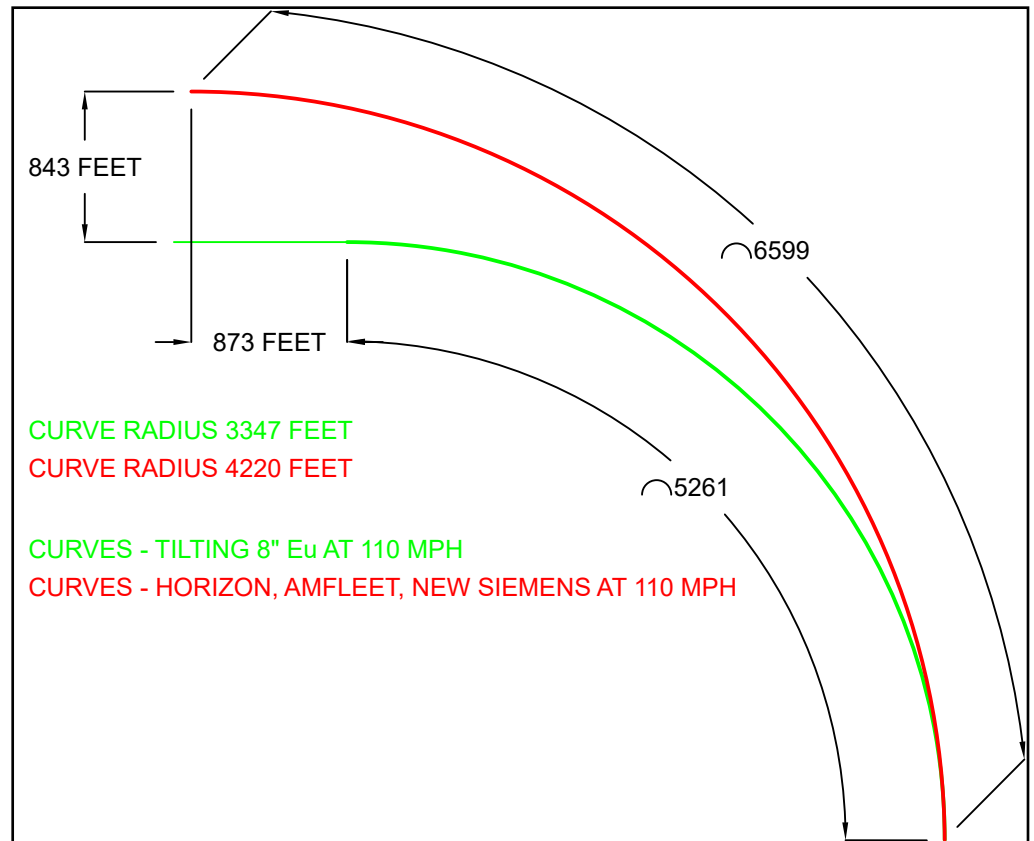



Appendix E Schematic of LRP Infrastructure Program



Passenger Station



Operating Location

P - Passenger F - Freight



F/P Track CTC



F Exclusive Track CTC



P Exclusive Track CTC



P Exclusive Track 100-110 mph CTC



F/P Track Written/Verbal Control



F Exclusive Track /Verbal Control



P Exclusive Track /Verbal Control



Freight Yard Improvements



Passenger Yard Improvements

Original Configuration

Complete Program Configuration

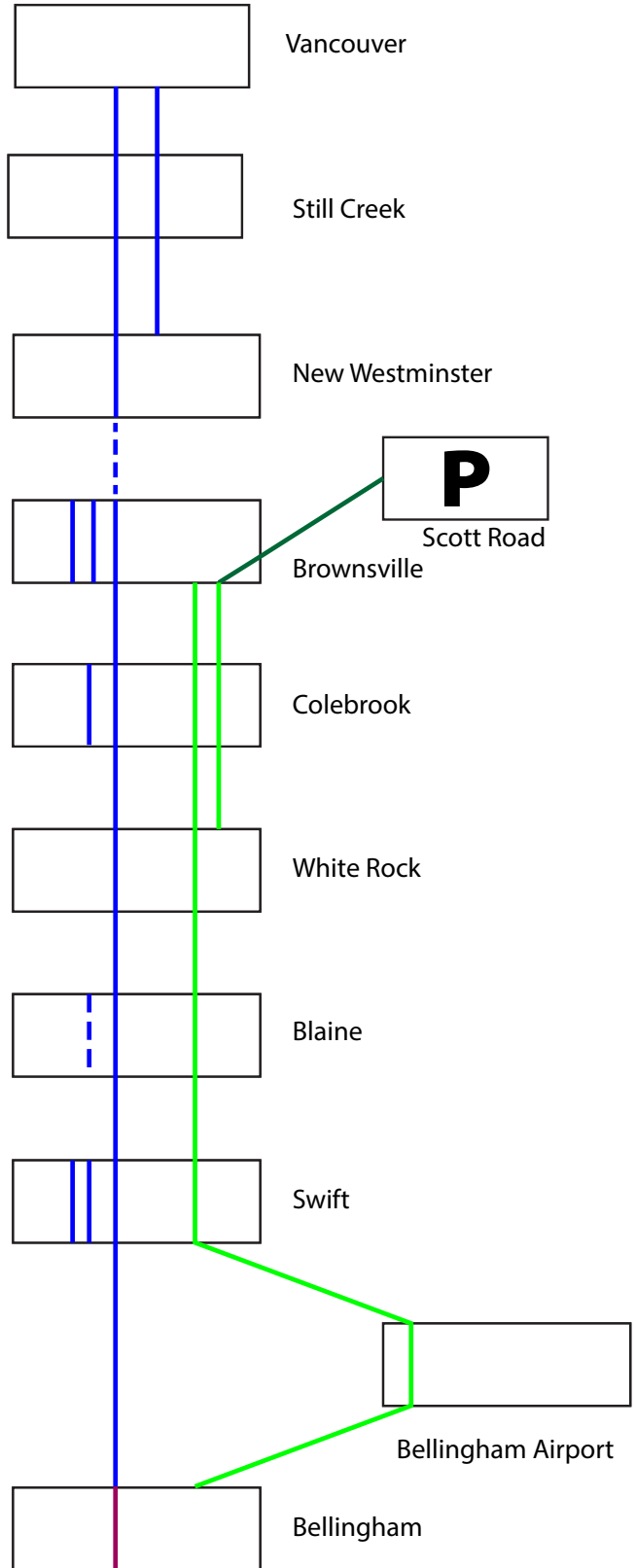
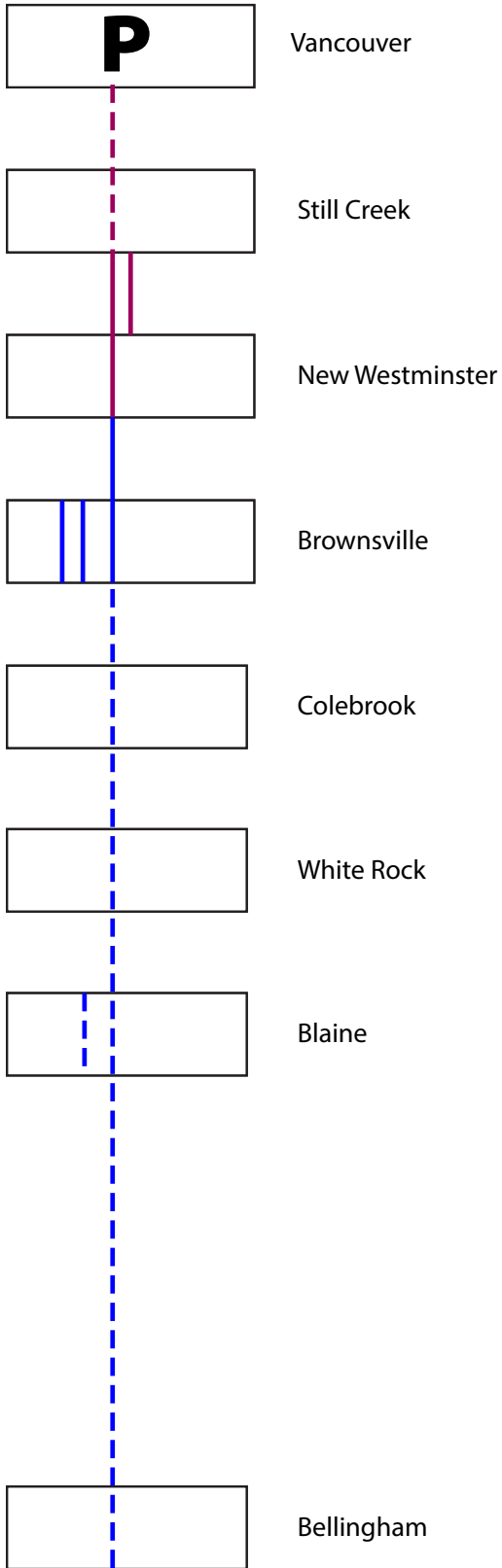

Original Configuration

Complete Program Configuration

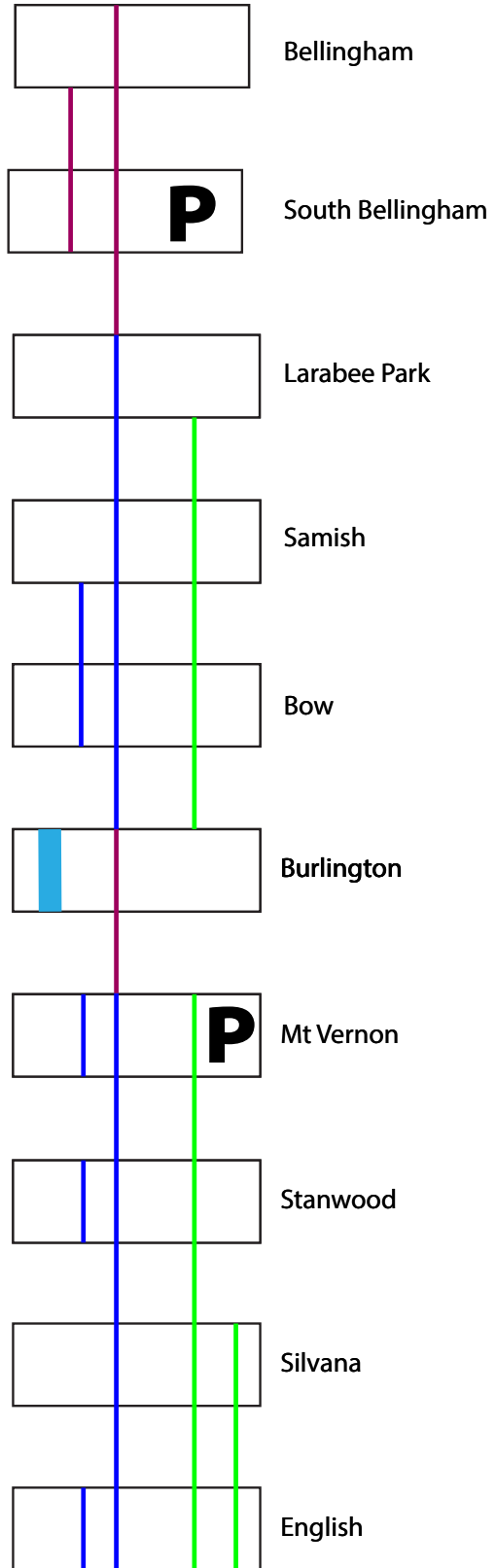
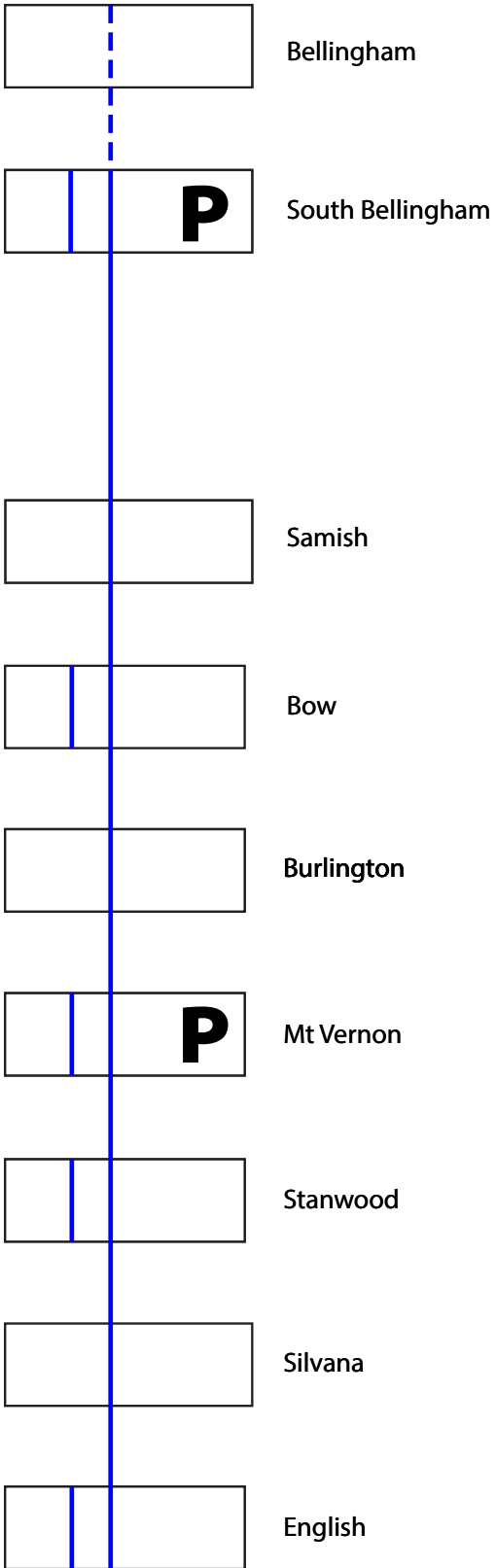

Original Configuration`

Complete Program Configuration

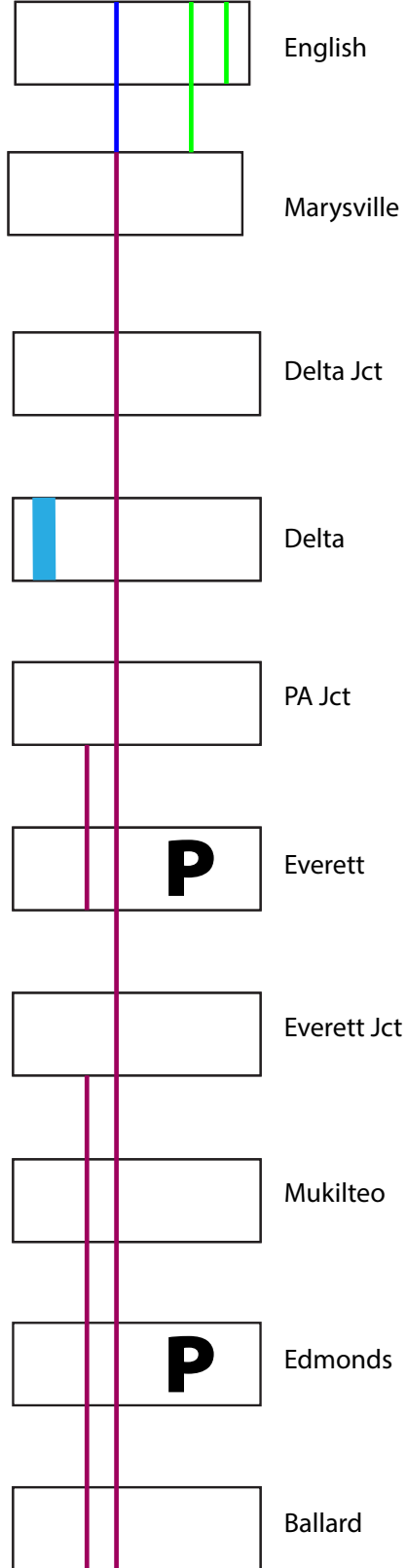
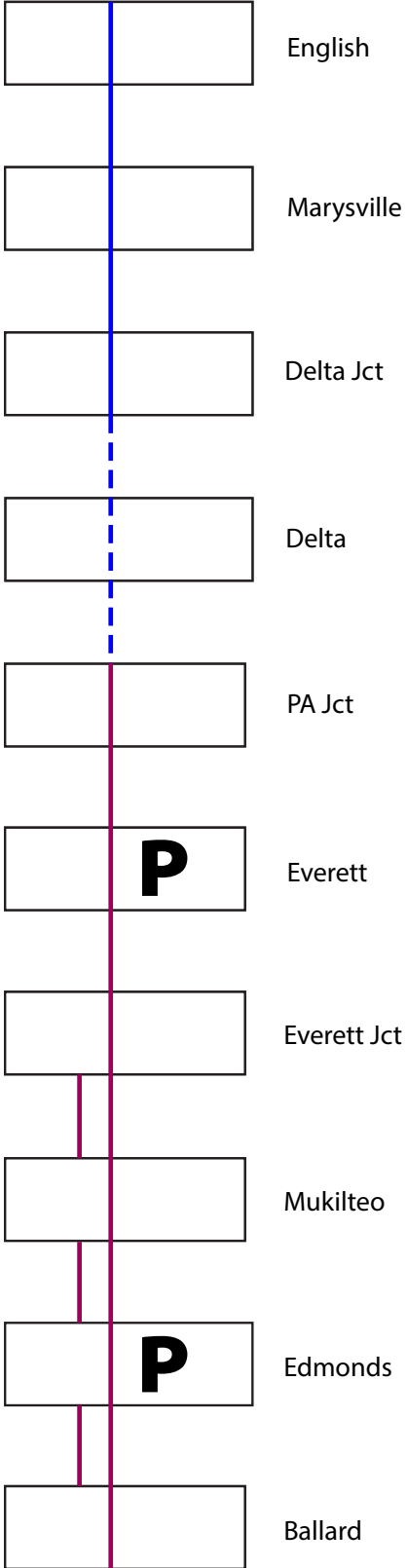

Original Configuration

Complete Program Configuration

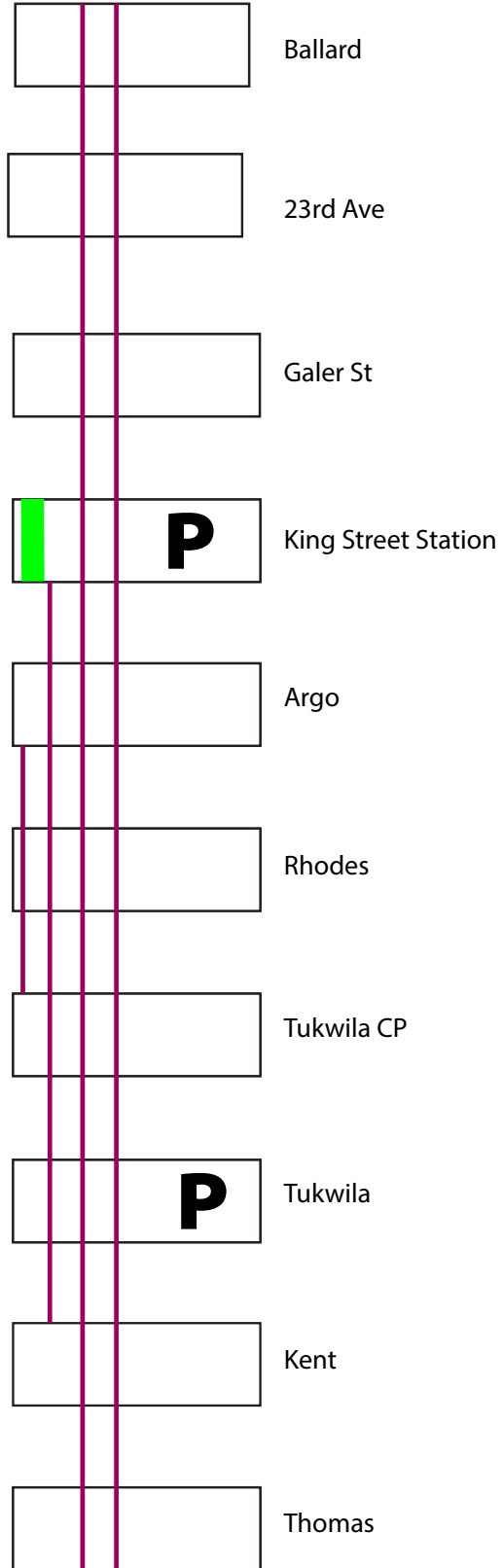
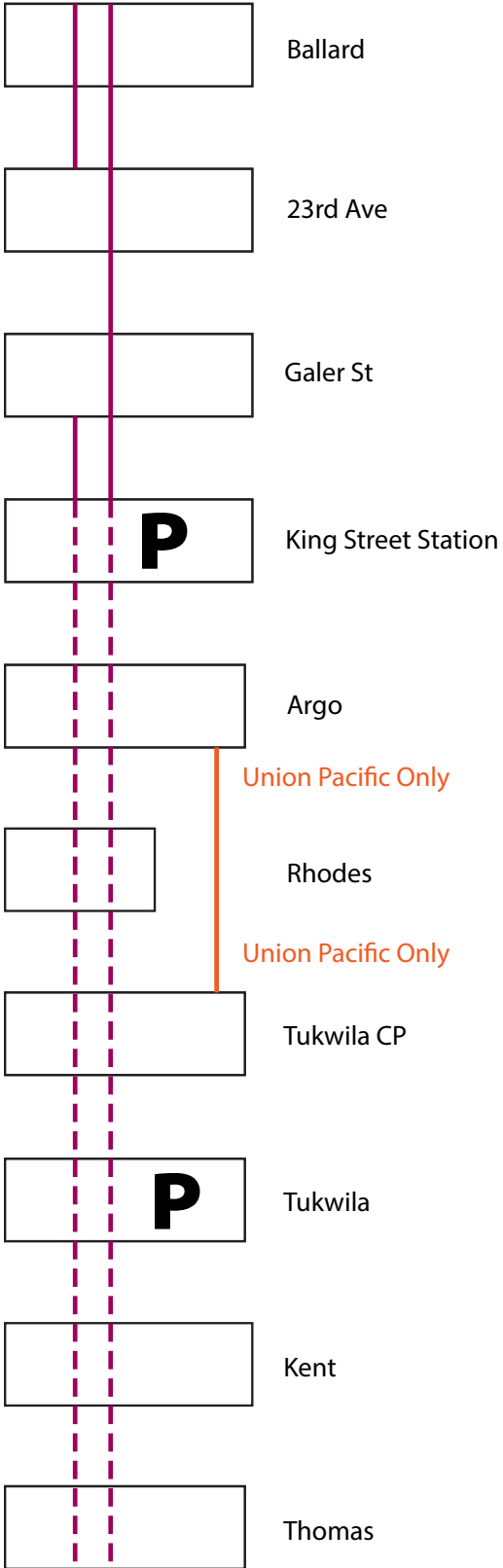

Original Configuration

Complete Program Configuration

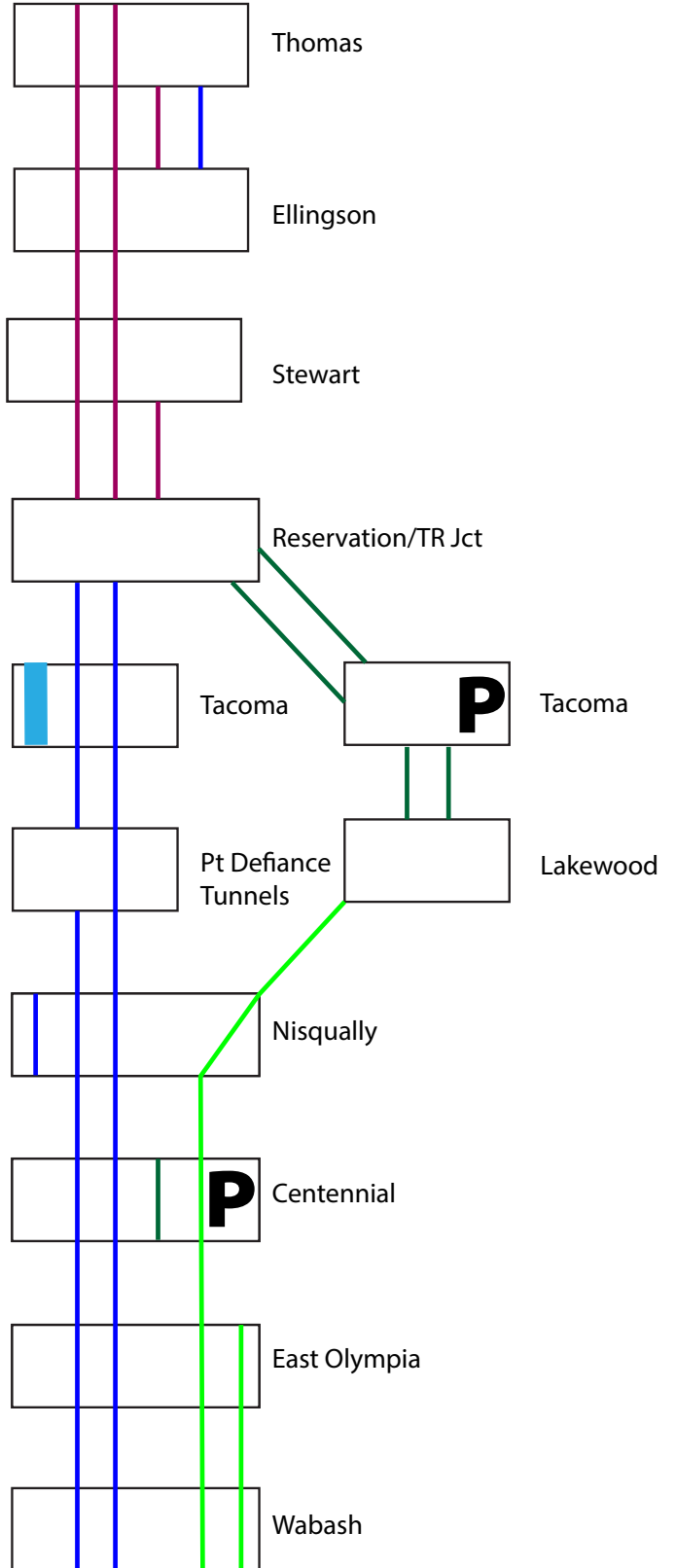
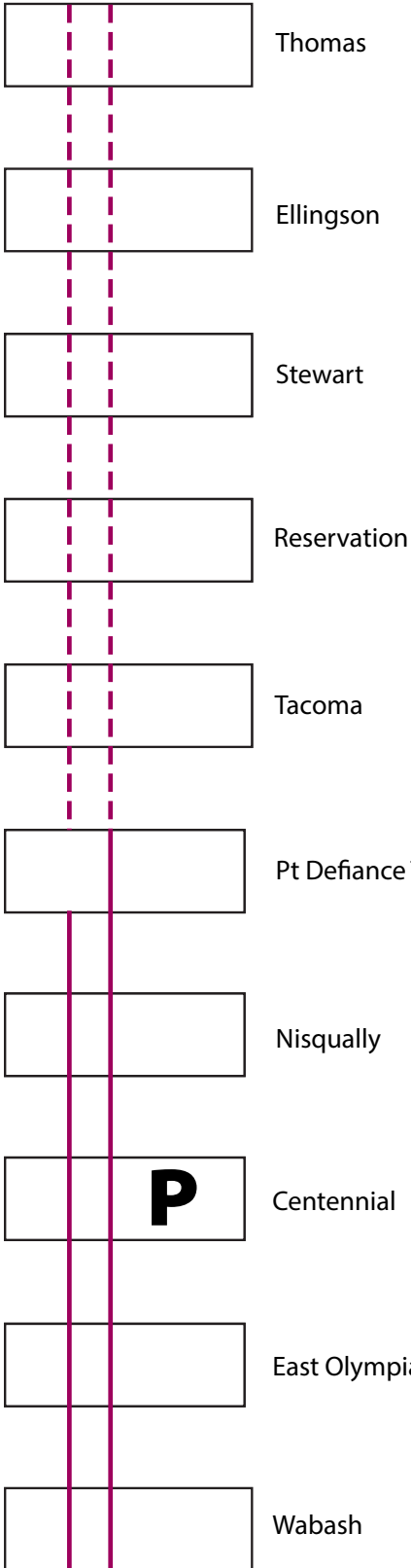

Original Configuration

Complete Program Configuration

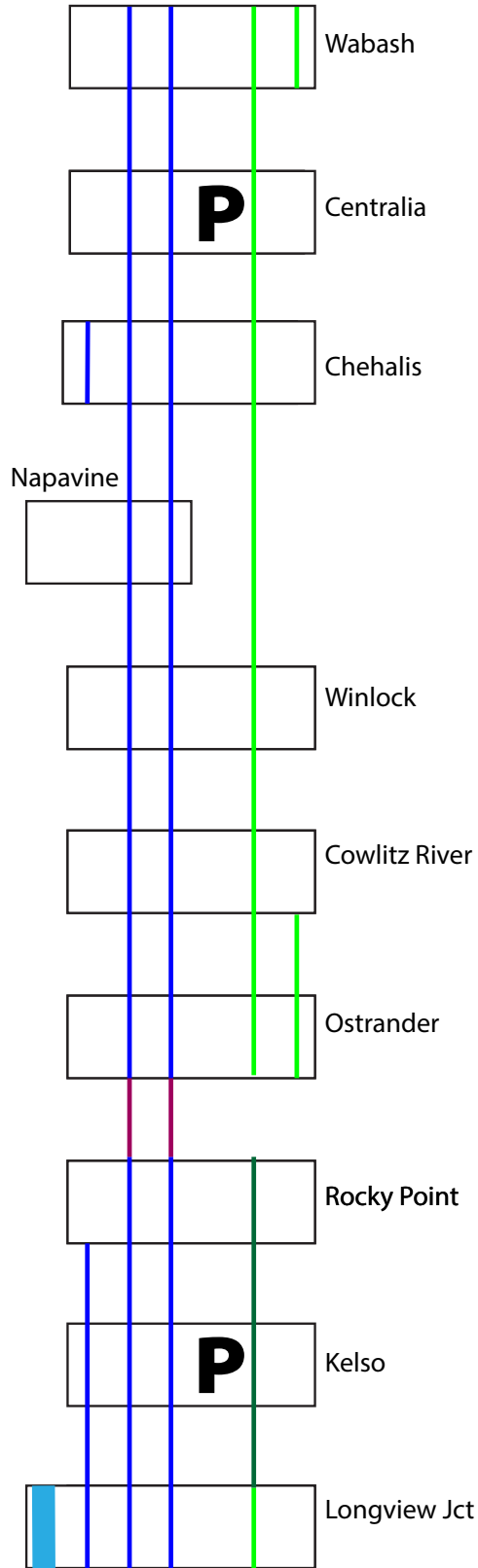
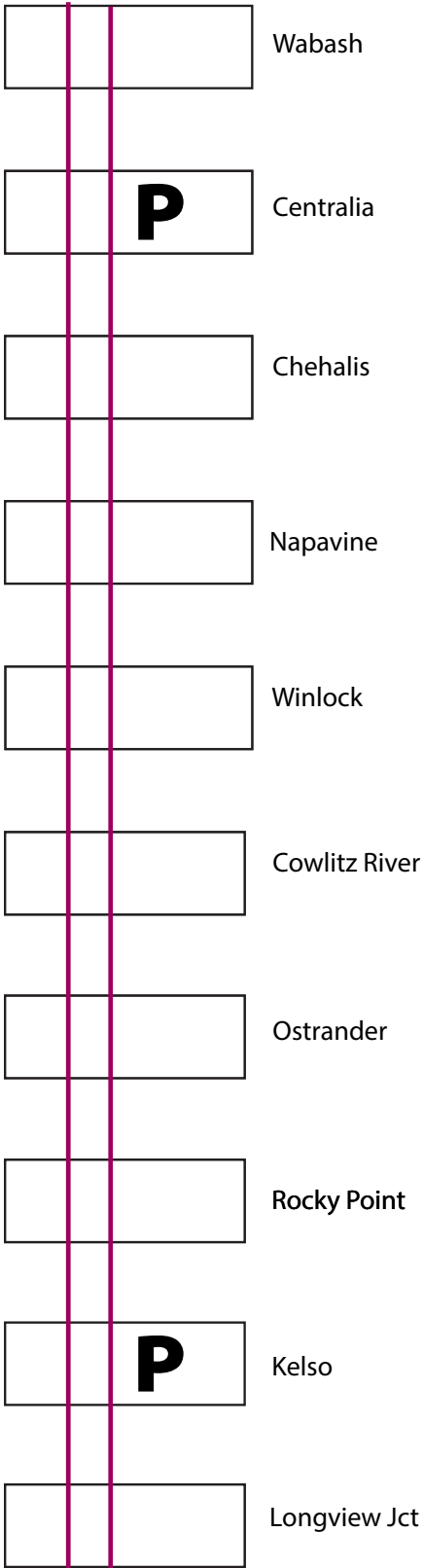

Original Configuration

Complete Program Configuration



Longview Jct



Kalama



Woodland



Felida



Vancouver



North Portland Jct



East St Johns



Wilamette River



Lake Yard



Portland



Longview Jct



Kalama



Woodland



Felida



Vancouver



North Portland Jct



East St Johns



Wilamette River



Lake Yard



Portland

Appendix F: Glossary

Alighting	Passengers getting off a train
Alignment	The path of the track (the location of the track, the curves, and tangent sections)
Alignment Change	Move the track to another path between two points, typically rerouting to reduce curve sharpness, or bypass a geologically unsound area (examples page 37)
Blocking Time	The amount of time that a train occupies a segment that can be occupied by only one train (Fig. 1 page 83)
Blocking Time Diagram	A stringline diagram that includes the blocking times (Fig. 2 page 83)
Boarding	Passengers getting on a train
Cant	The angle from horizontal of a line across the rails of a superelevated curve
Capacity	The number of trains that a route or part of a route the track arrangement can accommodate, typically measured in trains per day.
Capacity Limiting Segment	The segment of a route that has the greatest blocking time (Fig. 2 page 83)
Chaotic Operation	Running trains at seemingly convenient times without regard to the needs of trains already operating, unscheduled operation
Clock face	Frequency that involves every train operating at the same time every hour, e.g., 9:10 am, 10:10am, 11:10am throughout the service day
Conceptual Engineering (Conceptual Planning)	The level of planning that follows the feasibility study. Conceptual engineering puts the first level of detail to the concept in the feasibility study.
Crossover	An arrangement of two turnouts that allow a train to move from a track to a parallel track (Fig. 3 page 83)
CTC (Centralized Traffic Control)	A system of remote controlled switches and signals that the dispatcher uses to control and direct train movements and other uses of the main tracks (Fig. 4 page 84)
Degree of Curve	The central angle of the part of the curve that is subtended by a 100 foot chord.
Delay	An unscheduled stop
Delay Ratio	In infrastructure and traffic planning, typically the ratio of the amount of delay minutes to total trip time in minutes or delay minutes per 100 miles
Dispatcher (Train Dispatcher)	A railroad employee or official who controls the use of main tracks for an assigned district, managing traffic, maintenance work and other aspects of operation (Fig. 4 page 84)
Feasibility Study	Assessment of the practicality of a proposed project. It may identify at a high level, problems, benefits, costs, and other factors.
Frequency	How often trains operate
Hand Throw Switch	A switch that is aligned to the desired route by moving a manual control mechanism directly attached to the switch (Fig. 7 page 83)
Headway	The time between trains. For example, 10 minute headway means a train comes every 10 minutes.
Hold	Require a train to wait
Left Hand Running	Keeping to the left (like driving in England)
Line Change	See Alignment Change
Local Freight	A train that stops to pick up and/or deliver cars at customers along the line. Some local freight trains operate from end to end of a route. Others travel along part of a route and return to their initial station.
Main Track	A track used for the movement of trains between station.
Maintenance of Way	Maintenance of track, signals, bridges, road crossings, and related infrastructure
Meet	An encounter between trains moving in opposite directions.
Mode Shift	Shift traffic from one mode (highway, rail, marine, or air) to another
NEPA	National Environmental Policy Act
Operating Timetable	A publication containing instructions and information needed for operation of the railroad. An operating timetable may contain train schedules.
Overtake	Passing a train in the same direction that is moving slower than the train overtaking

Pass	An encounter between trains moving in the same direction: Overtake
Pick Up / Pickup	Cars to add to a freight train / the process of adding cars to a freight train (used interchangeably)
Platform	The paved area next to a track, used for passengers boarding and alighting, vehicles carrying baggage, and related purposes
Platform Extension	A section that extends the reach of a platform across a track to allow boarding and alighting on an adjacent track
Power Switch	Switch that is aligned to the desired route remotely using one or more electric motors
Preliminary Engineering	The next level beyond conceptual engineering, a mid-level design that produces schematics, preliminary drawings, and preliminary budgets.
Rail Can't Wait Campaign	
Reliability	How often the trains are on time
Right Hand Running	Keeping to the right like on a highway
Schedule	The itinerary of one train, showing stations at which the train will stop or pass by and the times at each
Service day	The period during which service is provided, the time between the first train of the day and the last.
Set Out / Setout	Leave cars off of a freight train / Cars to be removed from a train (used interchangeably)
Siding	A track for trains to pull off the main track and be passed or meet an opposing train
Signal	A device that conveys instructions, usually by colored lights, similar to a highway traffic signal. A signal may convey whether the track ahead is clear, how far the track ahead is clear, a speed limit, authority to continue moving on the main track, all or part of the above. (Fig. 4 page 84)
Station	A place designated by name in the operating timetable
Stringline Diagram	A time-Distance chart of train movements
Superelevation	Commonly called "banking" in roadway terms. The amount that the outer rail of the curve is raised above the inner rail. See illustrations in Appendix D (page 69).
Switch	The movable part of a turnout that directs wheels to one route or the other.
Tangent	Straight track
Through Freight	A freight train moving from terminal to terminal across the entire length of a route
Tilting Train	A train that has a body able to tilt to allow greater speed through curves than a conventional train allows (Appendix D page 69)
Timetable	The collection of train schedules for a route.
Traffic Diagram	Stringline Diagram
Turnout	An arrangement of rails that allows a train to change route (sometimes informally referred to as a switch) (Fig. 9 page 85)
Unbalance	A condition in which the force of gravity on the rail car is not perpendicular to the track. See illustrations in Appendix D (page 69).

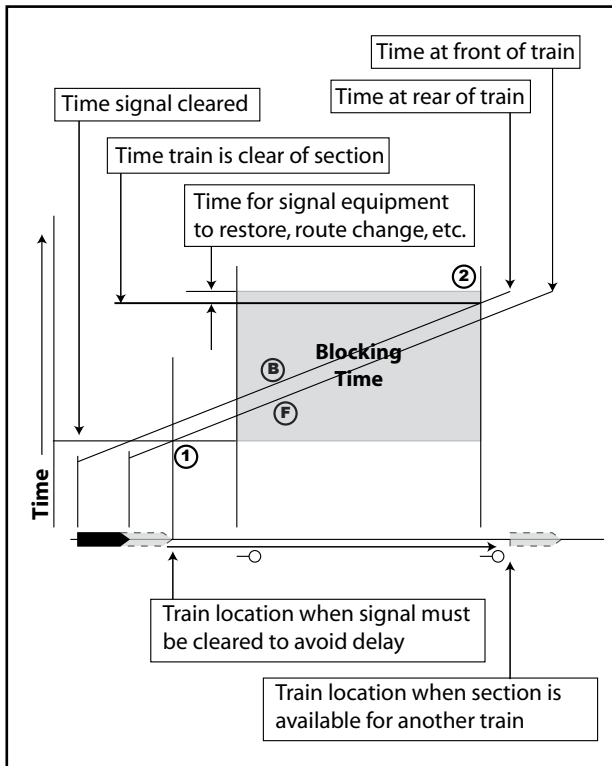

Fig. 1 Blocking time is the total amount of time that a train occupies a segment that can be occupied by only one train. Blocking time includes the time needed in advance to maintain speed through the segment.

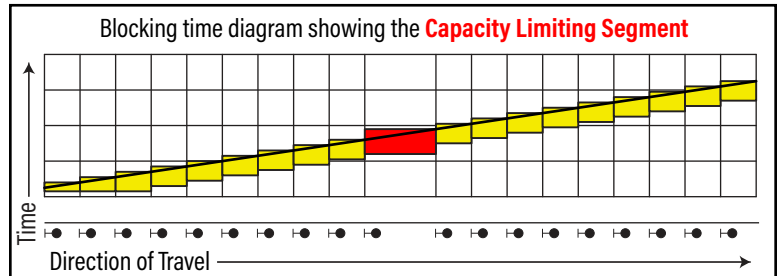

Fig. 2 In this Blocking Time Diagram, the segment with red blocking time is occupied the longest of any of the segments.

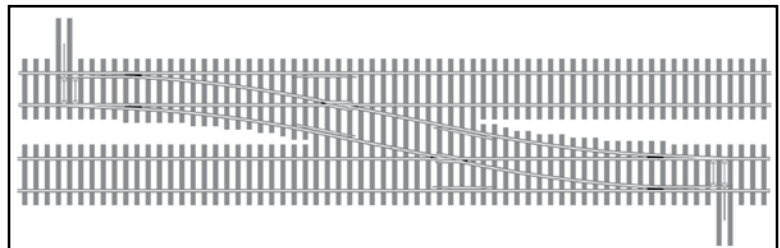

Fig. 3 A crossover - turnouts connecting parallel tracks

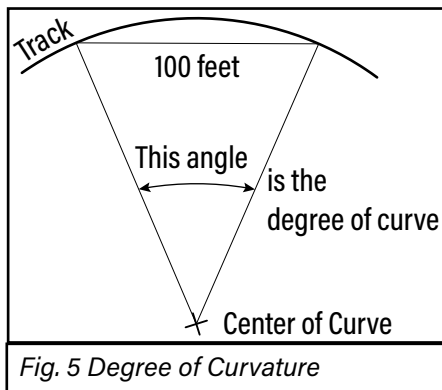
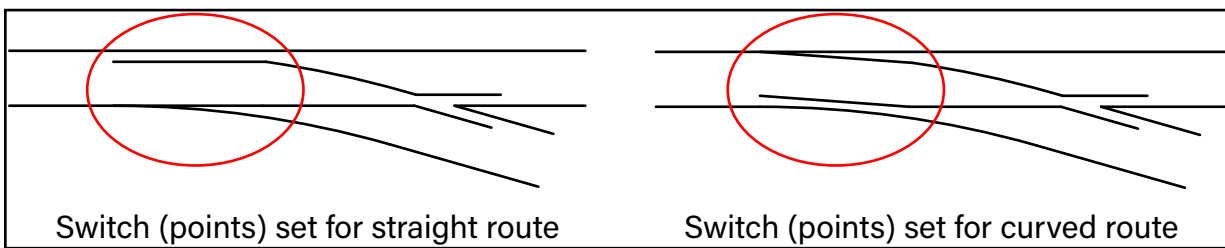

Fig. 5 Degree of Curvature



Fig. 7 Hand Throw Switch - member of train crew must get off train and manually set each switch for the desired route



Switch (points) set for straight route

Switch (points) set for curved route

Fig. 8 The switch (switch points) is the movable part of a turnout that directs the wheels to one of the two routes.

Dispatcher Workstation

The screens have a schematic diagram of the dispatcher's territory, showing track arrangement and train location. The dispatcher operates the control points by touch screen or keyboard.



BNSF Control Center Ft. Worth Dispatchers



Control Point

This one controls two tracks merging into one.
The freight train is standing at the stop signal.
The approaching passenger train has a proceed signal.

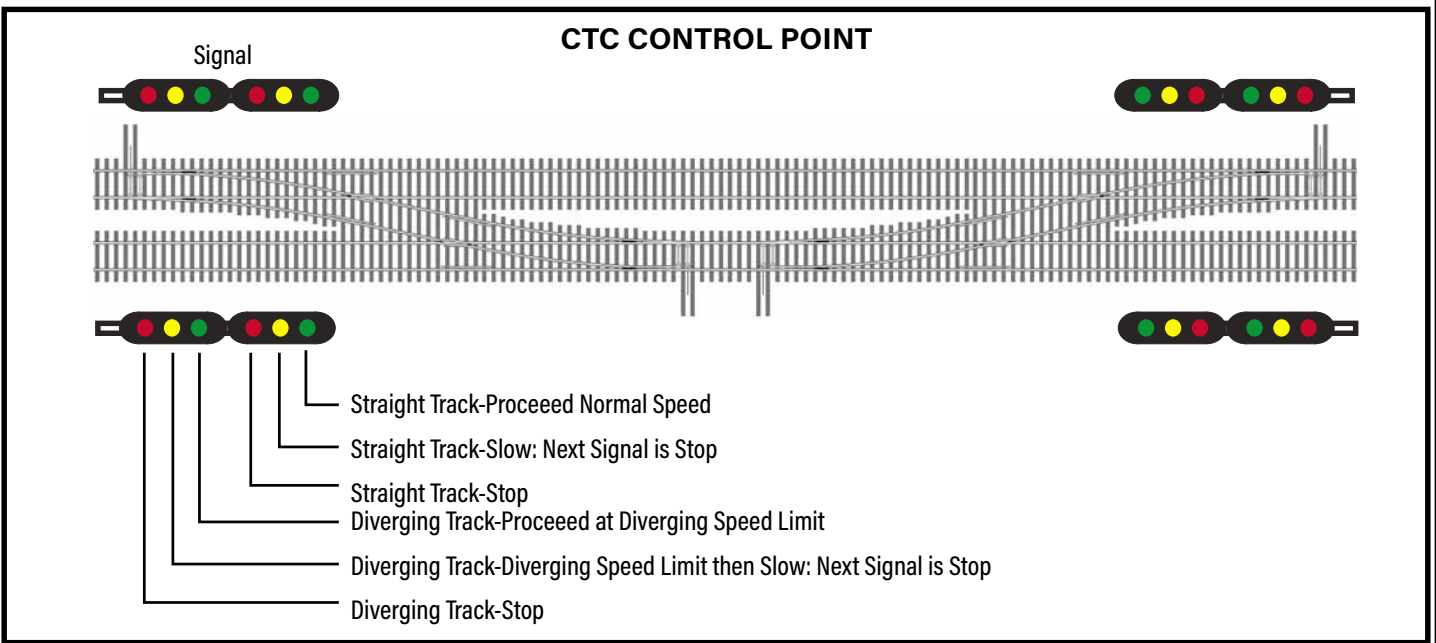
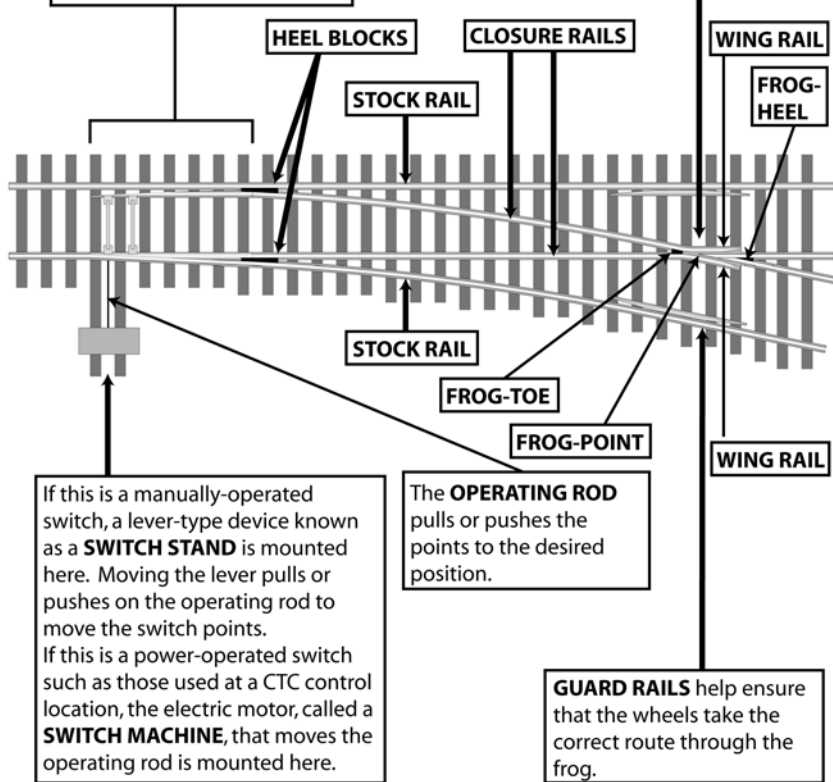

Fig. 4 CTC, the signals, turnouts, control system, and dispatchers

TURNOUTS

This section of a turnout is known as the **SWITCH** or the **POINTS**. The points pivot at one end and taper to a point at the other. The tapered end fits tightly against the stock rail to guide the wheels.

The wheel flange guides the wheel along the track. The flange cannot cross a rail. A **FROG** is an arrangement of rails that provides a gap in the rail of both routes to allow the wheels to cross the rail where the routes cross.



If this is a manually-operated switch, a lever-type device known as a **SWITCH STAND** is mounted here. Moving the lever pulls or pushes on the operating rod to move the switch points. If this is a power-operated switch such as those used at a CTC control location, the electric motor, called a **SWITCH MACHINE**, that moves the operating rod is mounted here.

The **OPERATING ROD** pulls or pushes the points to the desired position.

GUARD RAILS help ensure that the wheels take the correct route through the frog.

Fig. 9 Turnout

